

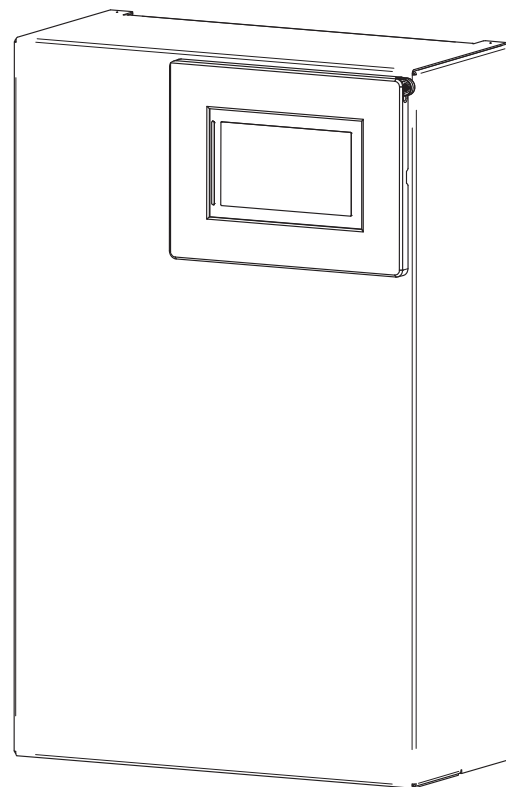

WPM Touch



Installation manual for technicians

Heat pump
manager

Table of contents

1	Safety notes	2
1.1	Symbols and markings.....	2
1.2	Regulations and safety notes.....	2
2	Heat pump manager: scope of supply	3
3	Mounting	4
3.1	Attaching the wall-mounted heat pump manager	4
3.2	Temperature sensor	5
3.2.1	Sensor characteristic curves.....	5
3.2.2	Mounting the outside temperature sensor	5
3.2.3	Installing the strap-on sensor	5
4	Electrical installation work for the heat pump	6
4.1	Electrical installation work.....	6
4.2	Functions	8
4.2.1	Overview of functions	8
4.2.2	Overview of pin assignment for fixed functional block	9
4.2.3	Overview of pin assignment for flexible functional block.....	9
4.3	Connection of electronically regulated circulating pumps	10
5	Special accessories	11
5.1	RTM Econ room temperature controller	11
5.2	Building management system.....	11
6	Technical device information	11

1 Safety notes

1.1 Symbols and markings

Particularly important information in these instructions is marked with **CAUTION!** and **NOTE**.

CAUTION!

Immediate danger to life or danger of severe personal injury or significant damage to property.

NOTE

Risk of damage to property or minor personal injury or important information with no further risk of personal injury or damage to property.

1.2 Regulations and safety notes

- During commissioning, observe the respective country-specific safety regulations and the applicable VDE safety regulations, particularly VDE 0100 as well as the technical connection requirements of the utility companies (EVU) and supply network operators!
- The heat pump manager should only be operated in dry rooms with temperatures ranging between 0 °C and 35 °C. Ensure that no condensation forms on the device.
- All sensor connecting cables with a conductor cross-section of 0.75 mm² can be extended to a maximum of 40 m. Sensor cables should not be installed next to power cables.
- To ensure that the frost protection function of the heat pump works properly, the heat pump controller must remain connected to the power supply and the flow must be maintained through the heat pump at all times.
- The switching contacts of the output relay are interference-suppressed. Therefore, depending on the internal resistance of the measuring instrument, a voltage can also be measured when the contacts are open. However, this will be much lower than the line voltage.
- At the adapter boards -N1/SL, -N1/ML, -N17/LV as well as the pins -N1/J9 .. J14 and J29 and -N17/J6 and J9, an extra-low voltage is present. If, due to a wiring error, the line voltage is mistakenly connected to these terminals, the heat pump manager will be destroyed.

2 Heat pump manager: scope of supply

The heat pump manager is available in two versions.

- Integrated in the heat pump casing
- Heat pump manager for wall mounting for a heat pump heating system

The scope of supply of the wall-mounted heat pump manager includes:

- Heat pump manager with casing
- 3 dowels (6 mm) with screws for wall mounting
- Outside temperature sensor R1
- Demand sensor R2.2
- Touch display
- Installation manual for technicians
- Operating instructions for users and technicians

3 Mounting

3.1 Attaching the wall-mounted heat pump manager

The controller is attached to the wall with the 3 screws and dowels (6 mm) included in the scope of supply. The following installation procedure must be followed to avoid soiling or damaging the controller:

- Open the controller cover (Fig. 3.2 on page 4)
- Mount the dowels for the upper fastening eyelet at operator level.
- Screw the screw into the dowel so that the controller can be mounted.
- Mount the controller by the upper fastening eyelet.
- Mark the position of the side drill-holes.
- Unhook the controller.
- Mount the dowels for the side drill-holes.
- Remount the controller at the top and tighten the screws.



Abb. 3.1: Dimensions of the wall-mounted heat pump manager (heating)



Abb. 3.2: Open the cover

3.2 Temperature sensor

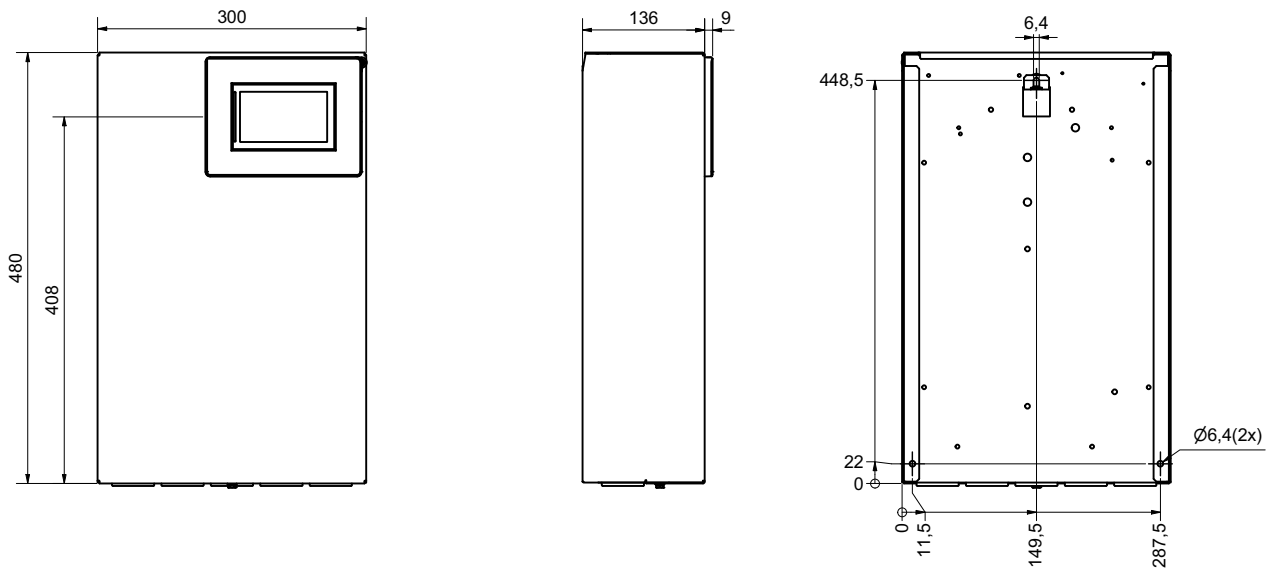
Depending on the heat pump type used, the following temperature sensors are already installed or must be additionally mounted:

NTC-2 sensor:

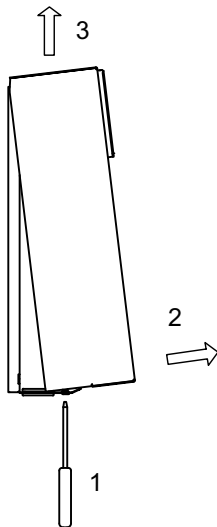
- Outside temperature sensor (R1)

NTC-10 sensor:

- 1st, 2nd and 3rd heating circuit temperature sensors (R35, R5 and R21)
- Demand sensor (R2.2)
- Domestic hot water temperature sensor (R3)
- Renewable cylinder temperature sensor (R13)

3.2.1 Sensor characteristic curves

Temperature in °C	-20	-15	-10	-5	0	5	10			
NTC-2 in kΩ	14.6	11.4	8.9	7.1	5.6	4.5	3.7			
NTC-10 in kΩ	67.7	53.4	42.3	33.9	27.3	22.1	18.0			
	15	20	25	30	35	40	45	50	55	60
	2.9	2.4	2.0	1.7	1.4	1.1	1.0	0.8	0.7	0.6
	14.9	12.1	10.0	8.4	7.0	5.9	5.0	4.2	3.6	3.1

The temperature sensors to be connected to the heat pump manager must correspond to the sensor characteristic curve illustrated in Fig. 3.3 on page 5. The only exception is the outside temperature sensor included in the scope of supply of the heat pump (see Fig. 3.4 on page 5)



Abb. 3.3: Sensor characteristic curve NTC-10 for connecting to the heating controller



Abb. 3.4: Sensor characteristic curve NTC-2 according to DIN 44574

3.2.2 Mounting the outside temperature sensor

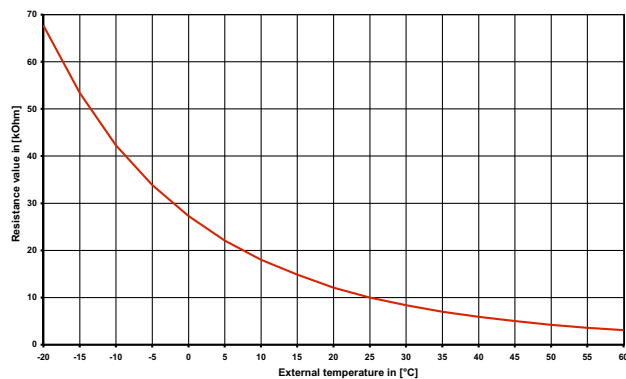
The temperature sensor must be mounted in such a way that all weather conditions are taken into consideration and the measured value is not falsified.

- Mount on the external wall on the north or north-west side where possible
- Do not install in a "sheltered position" (e.g. in a wall niche or under a balcony)
- Do not install in the vicinity of windows, doors, exhaust air vents, external lighting or heat pumps
- Not to be exposed to direct sunlight at any time of year

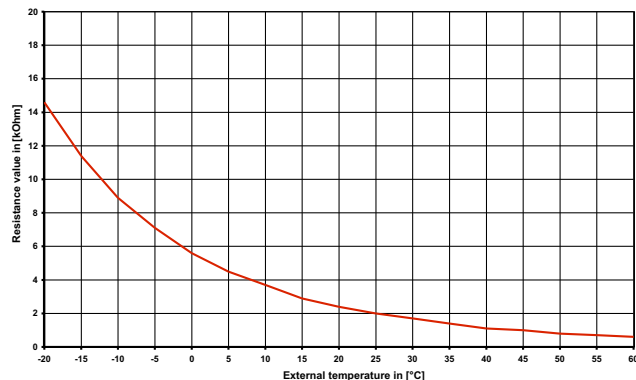
Dimensioning parameters sensor cable	
Conductor material	Cu
Cable length	50 m
Ambient temperature	35 °C
Routing type	B2 (DIN VDE 0298-4 / IEC 60364-5-52)
External diameter	4-8 mm

3.2.3 Installing the strap-on sensor

It is only necessary to mount the strap-on sensors if they are included in the scope of supply of the heat pump but have not yet been installed.

The strap-on sensors can be fitted as pipe-mounted sensors or installed in the immersion sleeve of the compact manifold.

Mounting as a pipe-mounted sensor

- Remove paint, rust and scale from heating pipe
- Coat the cleaned surface with heat transfer compound (apply sparingly)
- Attach the sensor with a hose clip (tighten firmly, as loose sensors can cause malfunctions) and thermally insulate

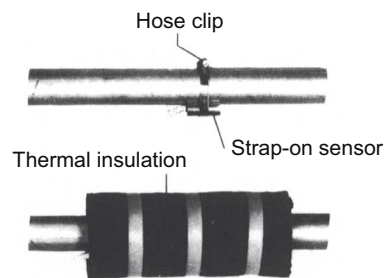

4 Electrical installation work for the heat pump

4.1 Electrical installation work

- 1) The electrical supply cable for the output section of the heat pump (up to 5-core) is fed from the electricity meter of the heat pump via the utility company blocking contactor (if required) into the heat pump (see heat pump operating instructions for supply voltage).
An all-pole disconnecting device with a contact gap of at least 3 mm (e.g. utility company blocking contactor or power contactor) and an all-pole circuit breaker with common tripping for all external conductors must be installed in the power supply for the heat pump (tripping current and characteristic in compliance with the device information).
- 2) The three-core electrical supply cable for the heat pump manager (N1) is fed into the heat pump (device with integrated controller) or to the future mounting location of the heat pump manager (WPM).
The supply cable (L/N/PE~230 V, 50 Hz) for the heat pump manager must have a continuous voltage. For this reason, it should be tapped upstream from the utility company blocking contactor or be connected to the household current, because otherwise important protection functions could be lost during a utility block.
- 3) The utility company blocking contactor (K22) with 3 main contacts (1/3/5 // 2/4/6) and an auxiliary contact (NO contact, e.g. 13/14) should be dimensioned according to the heat pump output and must be supplied on-site. The NO contact of the utility company blocking contactor (13/14) is connected to pin (1) (=DI1) of function block 0 (grey). CAUTION! Extra-low voltage!
- 4) The contactor (K20) for the immersion heater (E10) of mono energy systems (2nd heat generator) should be dimensioned according to the radiator output and must be provided on-site. The control (230 V AC) is performed from the heat pump manager, with the function applied via pin (7) (=NO3) of function block 0 (grey).
- 5) The contactor (K21) for the flange heater (E9) in the domestic hot water cylinder should be dimensioned according to the radiator output and must be provided on-site. The control (230 V AC) is performed from the heat pump manager via pin (7) of the defined function block.
- 6) The contactors mentioned above in points 3, 4 and 5 are installed in the electrical distribution system. The mains cables for the radiators should be dimensioned and protected according to DIN VDE 0100.
- 7) The heat circulating pump (M13) is connected to pin (5) (230 V AC) and (8) (control signal) of function block 0 (grey).
- 8) The external sensor (R1) is connected to pin (3) (=U1) of function block 0 (grey).

i NOTE

If three-phase pumps are implemented, a power contactor can be controlled via the 230 V output signal of the heat pump manager.

Sensor cables can be extended up to 50 m with 2 x 0.75 mm cables.

i NOTE

Further information on the wiring of the heat pump manager is available in the electrical documentation.

⚠ CAUTION!

The communication cable is necessary for the function of air-to-water heat pumps in outdoor installation. It must be shielded and laid separately from the mains cable. It is connected to N1-J25. For further information, see electrical documentation.



Abb. 4.1: Wall-mounted heat pump manager (heating)

4.2 Functions

In its basic configuration, the heat pump manager WPM Touch has a non-modifiable pin assignment for the function “General/1st unmixed circuit” on the “grey” function block. Further functions can be individually assigned on three function blocks (yellow, green, red) (see Cap. 4.2.1 on page 8).

If these three function blocks are not sufficient, it is possible to add two further function blocks (orange, blue) with the expan-

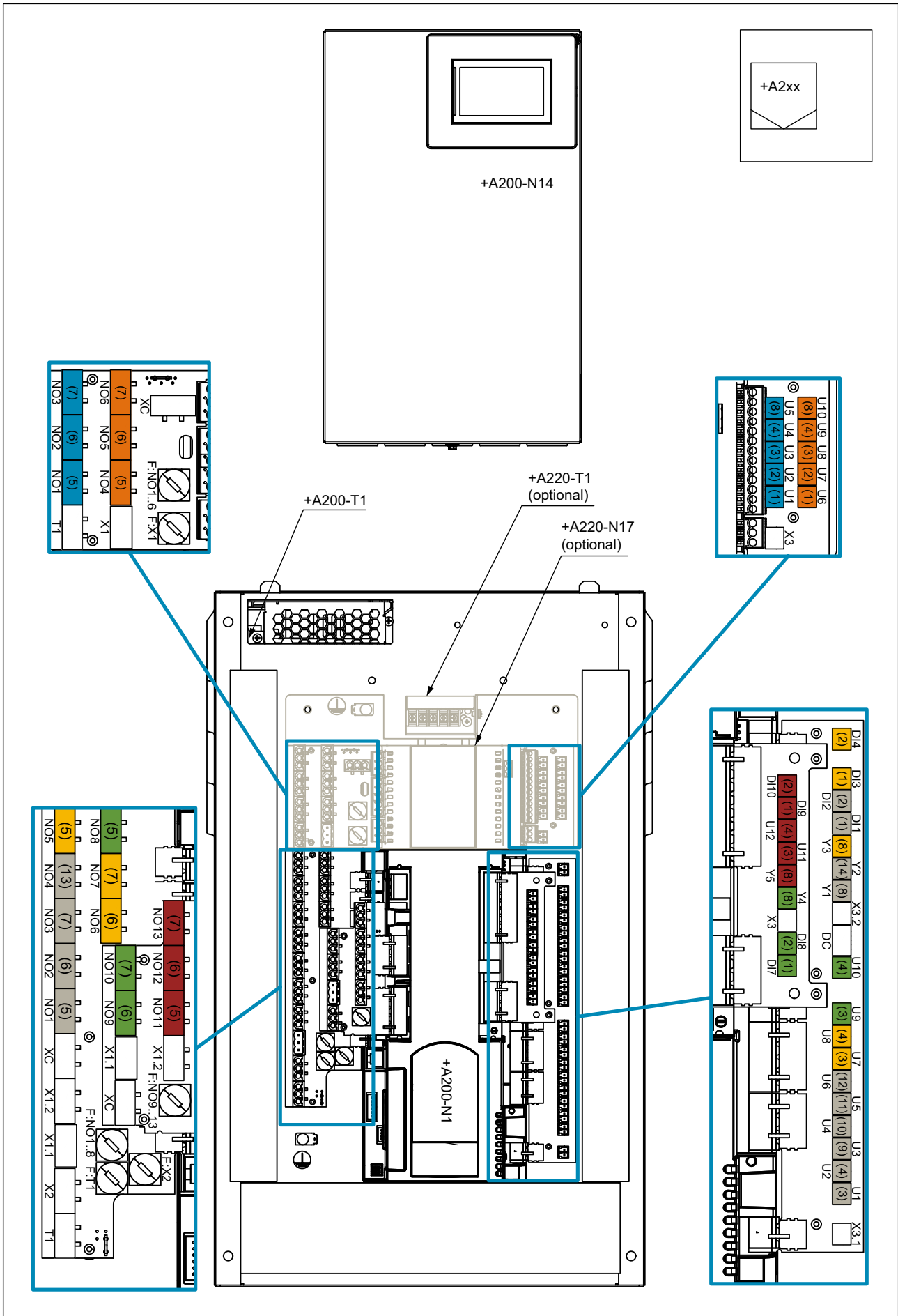
4.2.1 Overview of functions

General/1st unmixed circuit +A400	
A1/K22	Utility company disable contactor
A2/K23	External disable contactor
R1	Outside temperature sensor
R2.2	Demand sensor
M13	Heat circulating pump
H5	Remote fault indicator
E10.1/K20	Pipe heater/immersion heater
N27.1	Smart Grid green
N27.2	Smart Grid red
M16	Auxiliary circulating pump
AO M16	Auxiliary circulating pump control signal
Domestic hot water +A420	
K31	Circulation system requirements
B8	Thermostat
R3	Domestic hot water sensor
(Y)M18	Circulating pump/reversing valve
E9/K21	Flange heater
AO M18	Circulating pump control signal
1st mixed circuit +A411	
R35	Sensor
M13	Circulating pump
M21↑	Mixer open
M21↓	Mixer closed
2nd mixed circuit +A412	
R5	Sensor
M15	Circulating pump
M22↑	Mixer open
M22↓	Mixer closed
3rd mixed circuit +A413	
R21	Sensor
M20	Circulating pump
M29↑	Mixer open
M29↓	Mixer closed
Bivalent +A441	

sion which is available as a special accessory. A maximum of five function blocks are possible (yellow, green, red, orange, blue).

i NOTE

The “Active cooling” function can only be selected for a reversible heat pump.

E10.2/3	Oil/gas boiler
M26↑	Mixer open
M26↓	Mixer closed
Renewable +A442	
R13	Sensor
M27↑	Mixer open
M27↓	Mixer closed
Swimming pool +A430	
B4	Thermostat
R20	Domestic hot water sensor
(Y)M19	Circulating pump/reversing valve
K36	Flange heater
AO M19	Circulating pump control signal
Cooling active +A451	
N5	Dew point monitor
K28	Switching heating/cooling
R24.2	Return sensor primary circuit cooling
R39	Cooling demand sensor
N9/M17	Switching room thermostat/cooling circulating pump
Y12↑	External 4-way reversing valve open
Y12↓	External 4-way reversing valve closed
Cooling passive +A452	
N5	Dew point monitor
K28	Switching heating/cooling
R11	Flow cooling water
R4	Return cooling water
M12	Primary circulating pump passive cooling
Y5/Y6	3 or 2-way valve
M17	Cooling circulating pump
Solar +A443	
R22	Solar cylinder
R23	Collector sensor
M24	Solar pump
Y11	Solar reversing valve

4.2.2 Overview of pin assignment for fixed functional block

	Pin number													
	1	2	3	4	5	6	7	8	9	10	11	12	13	14
function block 0	grey	grey	grey	grey	grey	grey	grey	grey	grey	grey	grey	grey	grey	grey
Function														
General / 1st unmixed circuit +A400	A1 K22	A2 K23	R1	R2.2	M13	H5	E10.2 K20	-	N27.1	N27.2	-	-	M16	M16 AO

4.2.3 Overview of pin assignment for flexible functional block

	Pin number								
	1	2	3	4	5	6	7	8	
Function block I	yellow	yellow	yellow	yellow	yellow	yellow	yellow	yellow	
Function block II	green	green	green	green	green	green	green	green	
Function block III	red	red	red	red	red	red	red	red	
Function block IV (Accessories)	orange	orange	orange	orange	orange	orange	orange	orange	
Function block V (Accessories)	blue	blue	blue	blue	blue	blue	blue	blue	
Function									
Domestic hot water +A420		K31	B3	R3	-	(Y)M18	M24	E9/K21	M18 AO
1st mixed circuit +A411		-	-	R35	-	M13	M21↑	M21↓	-
2nd mixed circuit +A412		-	-	R5	-	M15	M22↑	M22↓	-
3rd mixed circuit +A413		-	-	R21	-	M20	M29↑	M29↓	-
Bivalent +A441		-	-	-	-	E10.2/3	M26↑	M26↓	-
Renewable +A442		-	-	R13	-	-	M27↑	M27↓	-
Swimming pool +A430		-	B4	R20	-	M19	-	K36	M19 AO
Cooling active +A451		N5	K28	R24.2	R39	N9/M17	Y12↑	Y12↓	-
Passive cooling +A452		N5	K28	R11	R4	M12	Y5/Y6	M17	-
Solar +443		-	R22	R23	-	M24	Y11	-	-

Example: Pin assignment selection when the domestic hot water function is selected for the yellow function block

First of all, the function to be used (here domestic hot water) and the function block to be assigned in terms of colour (here yellow) are selected. In the table in the domestic hot water row, the component to be connected is now selected, for example the domestic hot water sensor R3. In the 1st row, the pin to be assigned from the yellow function block is then selected. In this

case the R3 domestic hot water sensor is to be connected to the yellow pin with the number 3. This process is to be selected for each component to be connected.

i NOTE

During commissioning of the system via the touch display, the function to be used with the applicable colour assignment is queried and set.

	Pin number								
	1	2	3	4	5	6	7	8	
Function block I	yellow	yellow	yellow	yellow	yellow	yellow	yellow	yellow	
Function block II	green	green	green	green	green	green	green	green	
Function block III	red	red	red	red	red	red	red	red	
Function block IV (Accessories)	orange	orange	orange	orange	orange	orange	orange	orange	
Function block V (Accessories)	blue	blue	blue	blue	blue	blue	blue	blue	
Function									
Domestic hot water +A420	→	K31	B3	R3	-	(Y)M18	M24	E9/K21	M18 AO
1st mixed circuit +A411		-	-	R35	-	M13	M21 ↑	M21 ↓	-

i NOTE

You can find the detailed electrical documentation in the accessories pack

i NOTE

Communication and control voltage cables are to be laid between a wall-mounted heat pump manager and the heat pumps

4.3 Connection of electronically regulated circulating pumps

Electronically regulated circulating pumps may have high starting currents, which may reduce the service life of the heat pump manager. In the event of a high or unknown starting current value, a coupling relay must be installed. The coupling relay must be supplied on-site. This is not necessary if the maximum permissible operating current of the heat pump manager (see information in electrical documentation) is not exceeded by the electronically regulated circulating pump or a relevant approval has been issued by the pump manufacturer.

i NOTE

The high-efficiency pumps (UPH) are supplied with the relevant coupling relay for connecting and operating the electronically regulated circulating pump.

⚠ CAUTION!

It is not permitted to connect more than one electronically regulated circulating pump via a relay output.

5 Special accessories

5.1 RTM Econ room temperature controller

With cooling using panel heating/cooling systems, regulation is carried out according to the room temperature and air humidity measured by the room controllers.

The minimum possible cooling water temperature is calculated from the room temperature and air humidity measured in the reference room. The control response of the cooling system is influenced by the currently measured room temperature and the set room set temperature.



Abb. 5.1: Room temperature controller

5.2 Building management system

The heat pump manager can be connected to a building management system network via supplementation of the relevant expansion interface. The supplementary installation instructions of the expansion interface must be consulted regarding the exact connection and parametrisation.

The following network connections can be made on the heat pump manager:

- EIB, KNX
- Ethernet
- Modbus TCP
- Modbus RTU

6 Technical device information

Line voltage	230 V AC 50 Hz
Voltage range	195 to 253 V AC
Power consumption	Approx. < 50 VA
Degree of protection according to EN 60529	IP 20
Switching capacity of outputs	min. 2 A (2 A) $\cos(\varphi) = 0.6$ LRA = 12 A at 230 V
Switch-off capacity	≥ 1.5 kA
Operating temperature	0 °C bis / to / à +35 °C
Storage temperature	-15 °C bis / to / à +60 °C
Gewicht / Weight / Poids	-
Mode of action	Type 1.C
Degree of soiling	2
Heat/fire resistance	Category D
Temperature for ball pressure test	125 °C



Glen Dimplex Deutschland

Head office

Glen Dimplex Deutschland GmbH
Am Goldenen Feld 18
D-95326 Kulmbach

T +49 9221 709-100
F +49 9221 709-339
dimplex@glendimplex.de
www.glendimplex.de

Service and technical support

After-sales service, technical support
and spare parts
Assistance before and after installation
of your equipment

T +49 9221 709-545
F +49 9221 709-924545
Mon - Thu: 7:30 to 16:30
Fri: 7:30 to 15:00
service-dimplex@glendimplex.de

Our 24 hr hotline is available
for emergencies outside
normal opening times

Request after-sales service on the internet:
www.glendimplex.de/dienstleistungen-dimplex