

# M Flex

## M Flex 0609

## M Flex 0916

## M Flex 0916M

# 1

## electrical layout

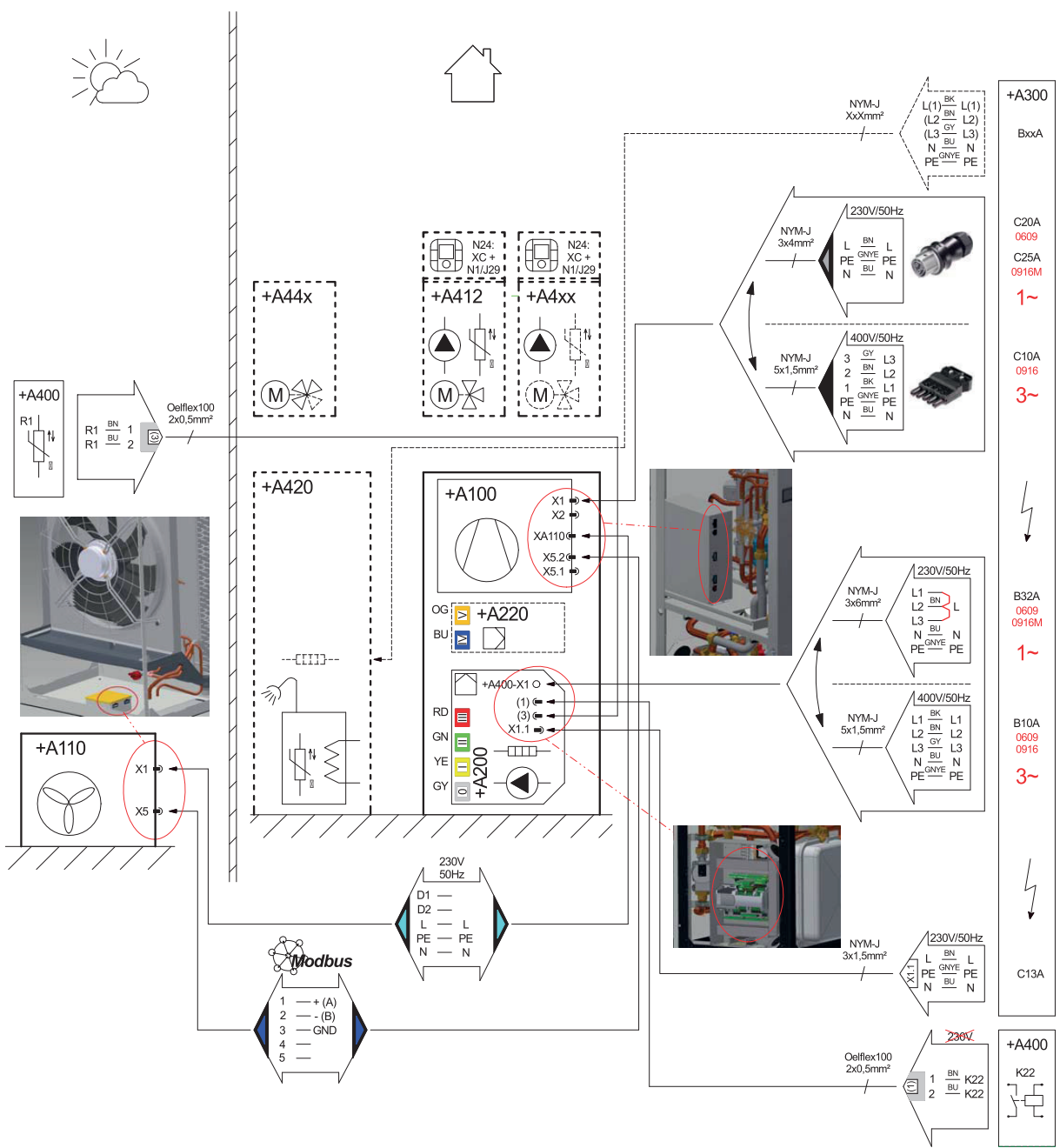



# 2

## hydraulic

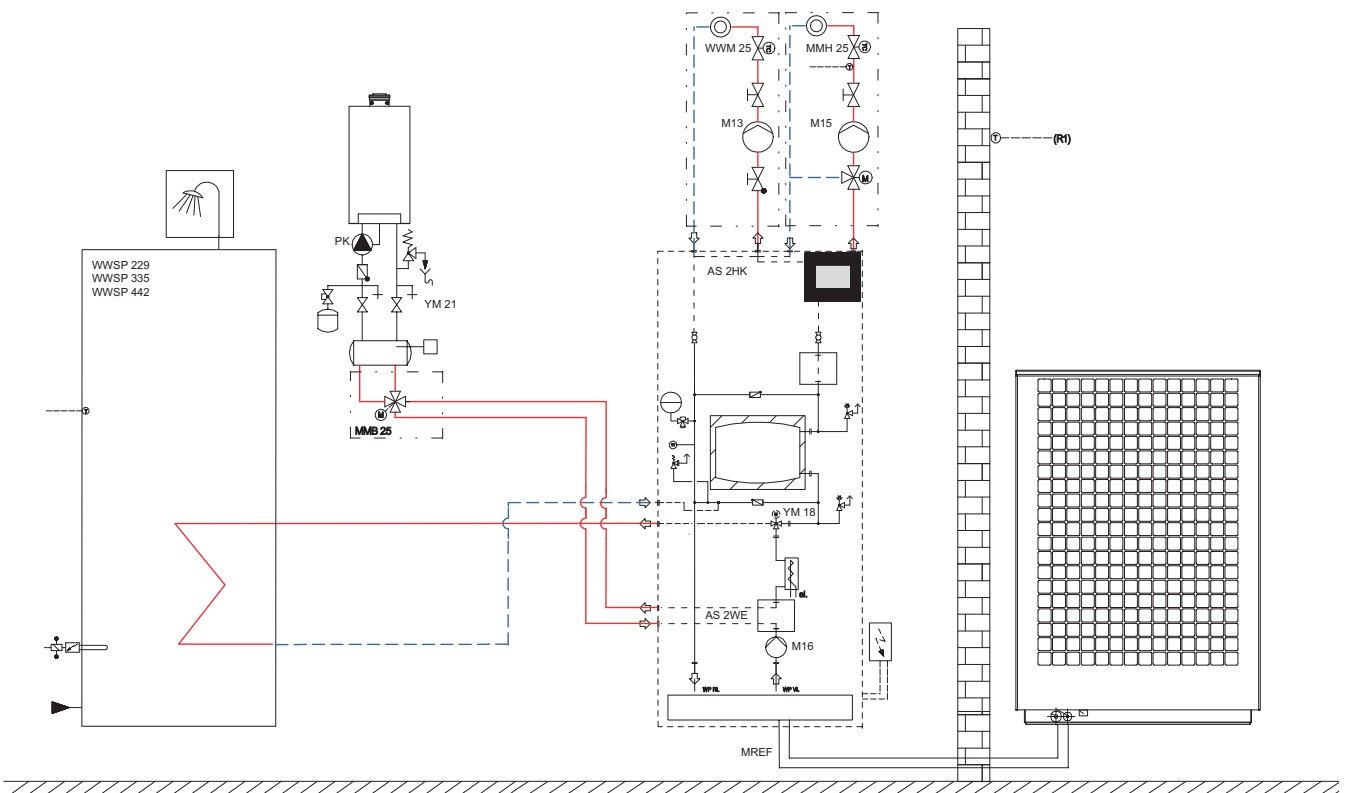
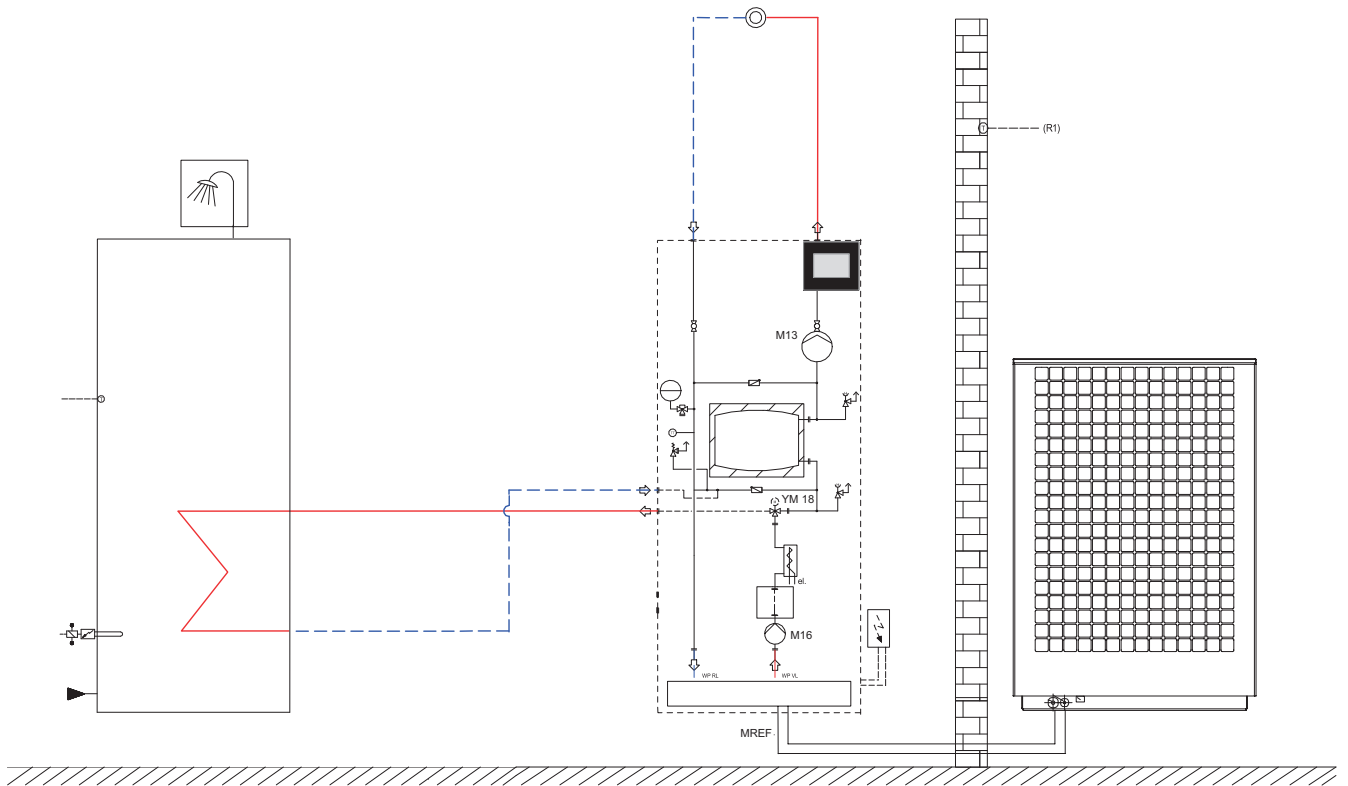

# 3

## plug in

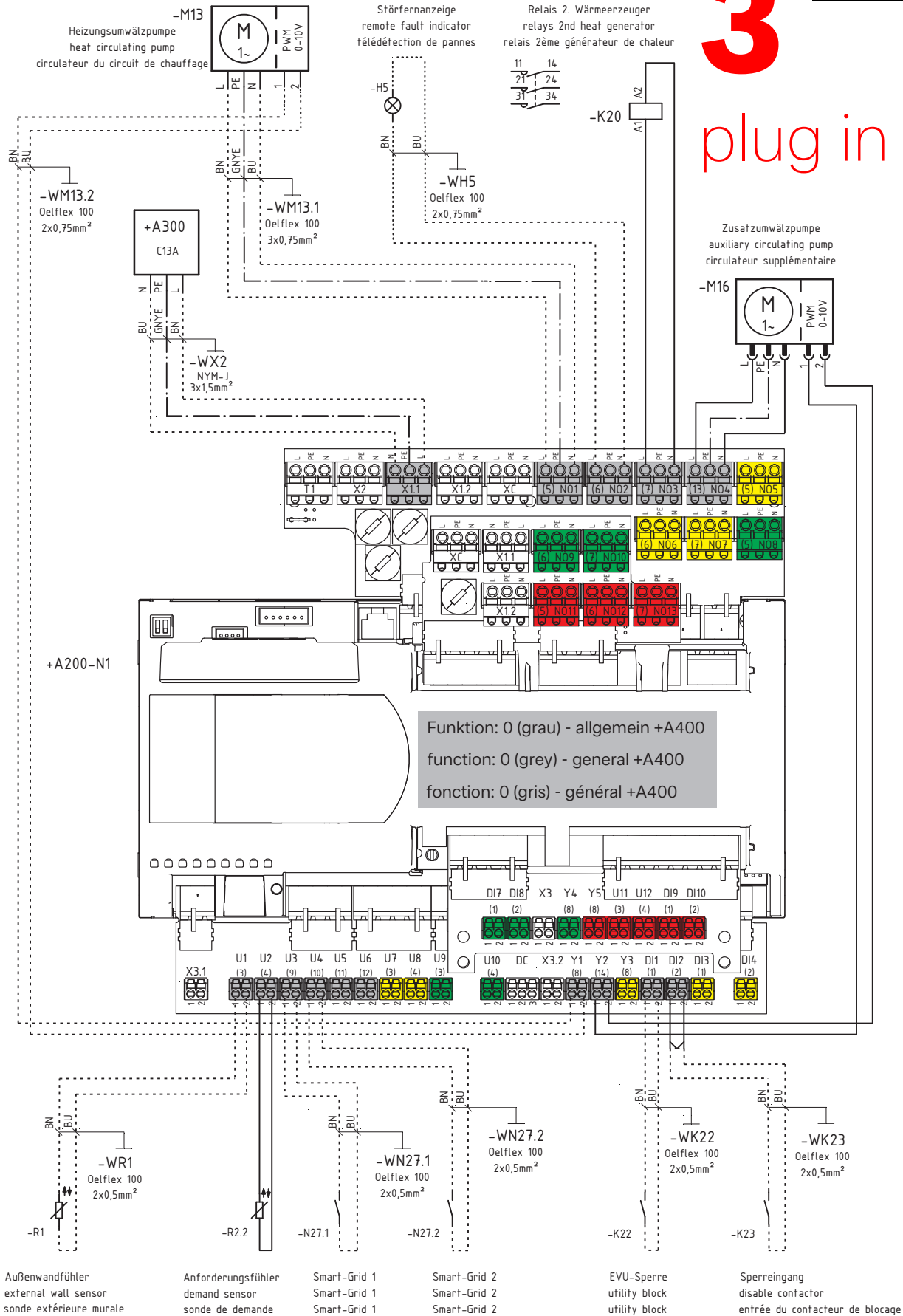



Glen  
Dimplex  
Deutschland

Dimplex

Zirkulationspumpe Warmwasser  
circulation pump domestic hot water  
circulateur de bouclage ECS eau chaude sanitaire

Relais Flanschheizung -E9  
relays flange heater -E9  
relais cartouche chauffante -E9

Umschaltventil Warmwasser  
reversing valve domestic hot water  
vanne d'inversion eau chaude sanitaire

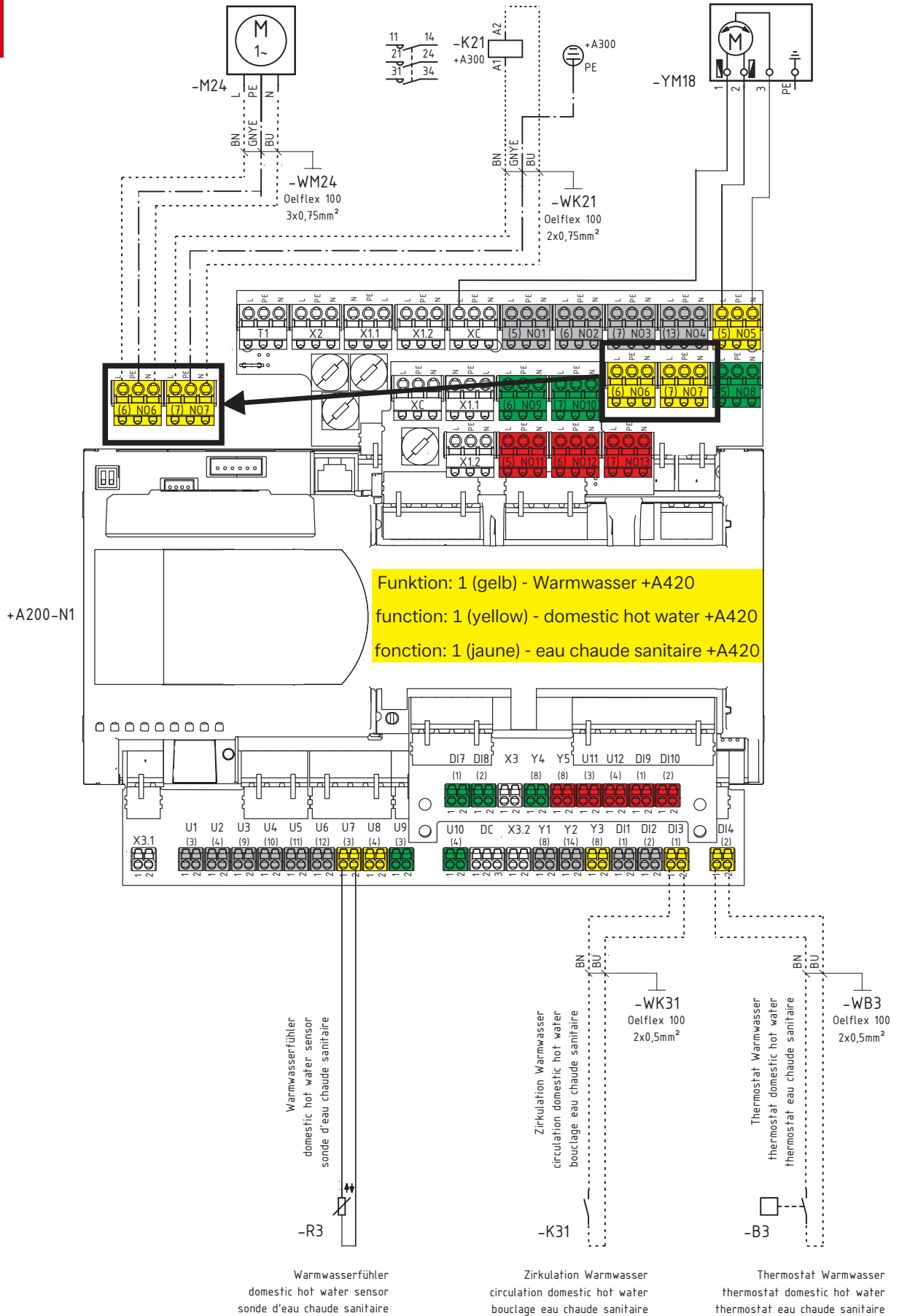

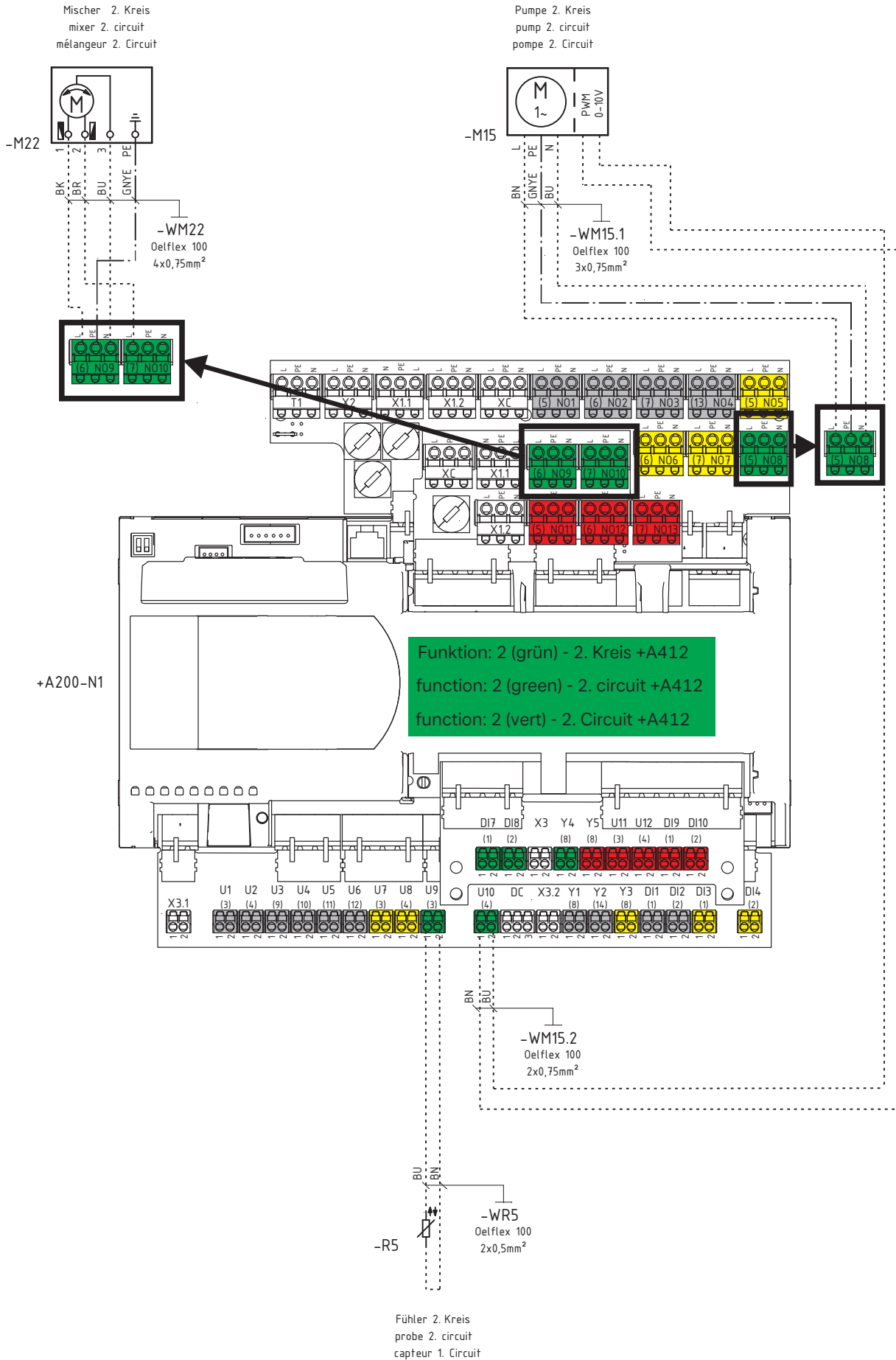



Glen  
Dimplex  
Deutschland

Dimplex

Wärmeerzeuger bivalent  
heat generator bivalent  
générateur de chaleur bivalente

Mischer bivalent  
mixer bivalent  
mélangeur bivalent

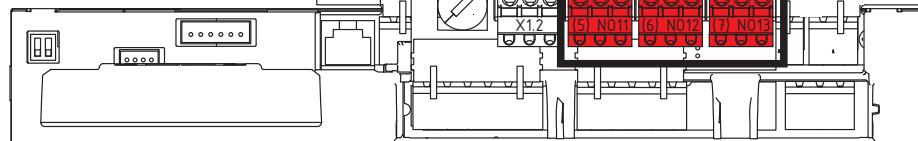
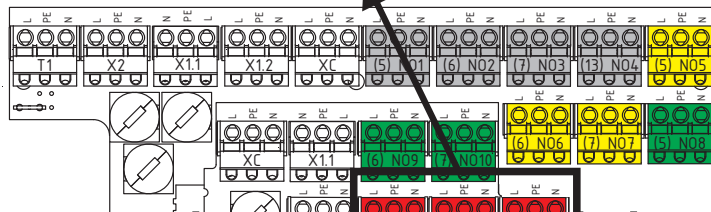
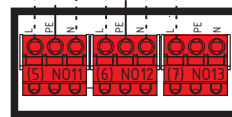
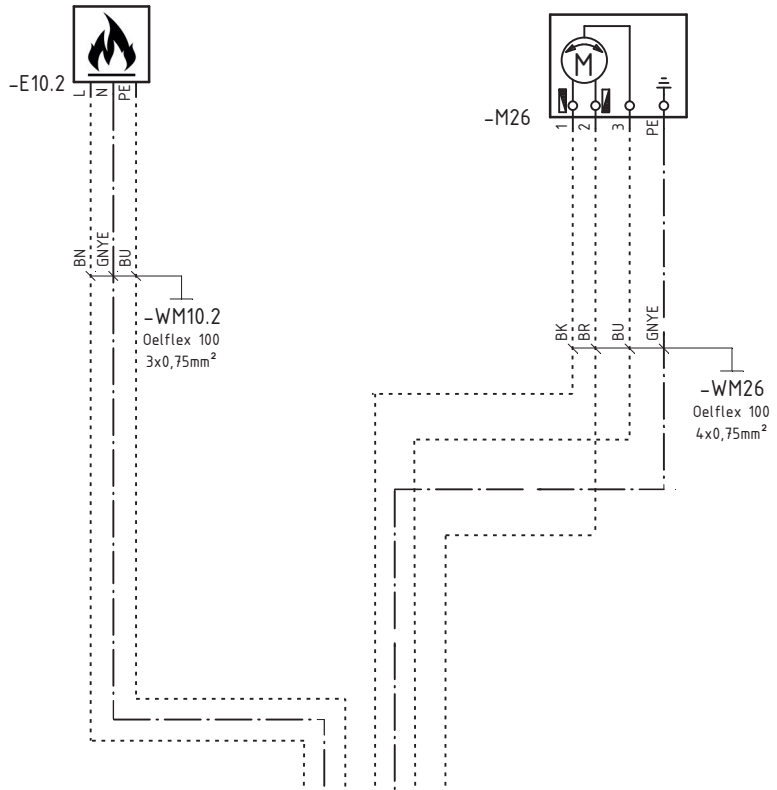

+A200-N1

Funktion: 3 (rot) -bivalent +A441  
function: 3 (red) -bivalent +A441  
fonction: 3 (rouge) - bivalent +A441

