

LA 60S-TU

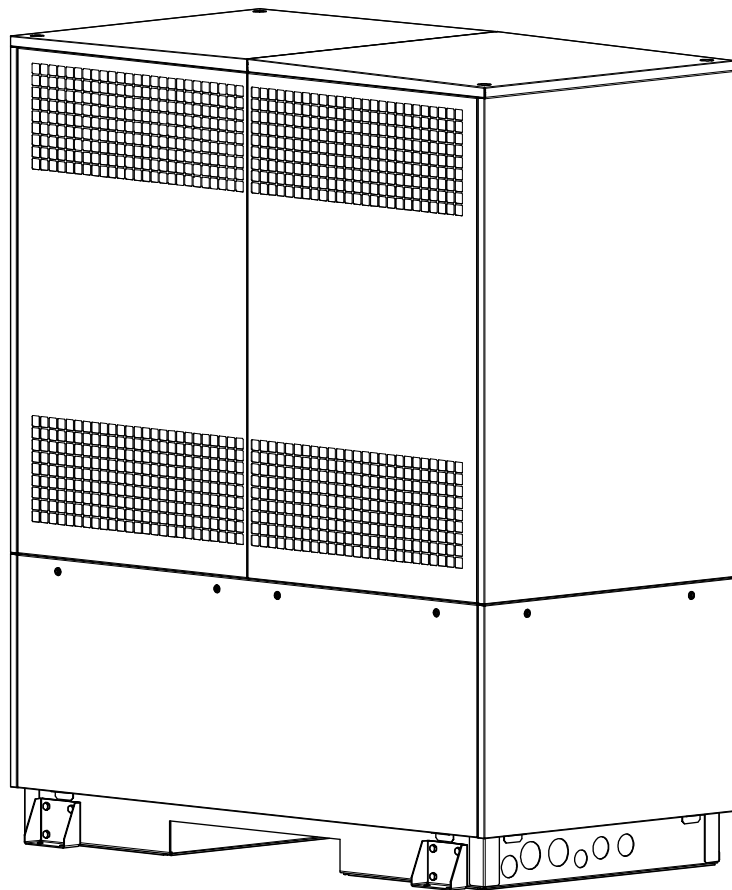

Installation and Operating Instruction

Air-to-Water
Heat Pump for
Outdoor Installation

Table of contents

1	Safety notes	EN-2
1.1	Symbols and markings.....	EN-2
1.2	Intended use.....	EN-2
1.3	Legal regulations and directives.....	EN-2
1.4	Energy-efficient use of the heat pump.....	EN-2
2	Purpose of the heat pump	EN-3
2.1	Application	EN-3
2.2	Operating principle.....	EN-3
3	Scope of supply	EN-4
3.1	Basic device	EN-4
3.2	Switch box.....	EN-4
3.3	Heat pump manager.....	EN-4
4	Transport	EN-5
5	Installation	EN-5
5.1	General.....	EN-5
5.2	Condensate pipe	EN-6
6	Assembly	EN-6
6.1	General.....	EN-6
6.2	Connection on heating side	EN-6
6.3	Electrical connection	EN-7
7	Start-up	EN-8
7.1	General.....	EN-8
7.2	Preparation.....	EN-8
7.3	Procedure	EN-8
8	Cleaning / maintenance	EN-8
8.1	Maintenance	EN-8
8.2	Cleaning the heating system	EN-8
8.3	Cleaning the air system.....	EN-9
9	Faults / troubleshooting	EN-9
10	Decommissioning / disposal	EN-9
11	Device information	EN-10
12	Product information as per Regulation (EU) No 813/2013, Annex II, Table 2	EN-12
13	Dimension Drawings	EN-13
13.1	Dimension Drawing	EN-13
14	Diagrams	EN-14
14.1	Characteristic curves for heating operation	EN-14
14.2	Operating limits diagram heating	EN-15
15	Integration diagram	EN-16
15.1	Hydraulic integration diagrams	EN-16
15.2	Legend.....	EN-17
16	Declaration of Conformity	EN-17

1 Safety notes

1.1 Symbols and markings

Particularly important information in these instructions is marked with CAUTION! and NOTE.

CAUTION!

Immediate danger to life or danger of severe personal injury or significant damage to property.

NOTE

Risk of damage to property or minor personal injury or important information with no further risk of personal injury or damage to property.

1.2 Intended use

This device is only intended for use as specified by the manufacturer. Any other use beyond that intended by the manufacturer is prohibited. This requires the user to abide by the relevant project planning documents. Please refrain from tampering with or altering the device.

1.3 Legal regulations and directives

This heat pump is designed for use in a domestic environment according to Article 1, Paragraph 2 k) of EU directive 2006/42/EC (machinery directive) and is thus subject to the requirements of EU directive 2014/35/EU (low-voltage directive). It is thus also intended for use by non-professionals for heating shops, offices and other similar working environments, in agricultural establishments and in hotels, guest houses and similar / other residential buildings.

The construction and design of the heat pump complies with all relevant EU directives, DIN/VDE regulations (see CE declaration of conformity).

When connecting the heat pump to the power supply, the relevant VDE, EN and IEC standards are to be adhered to. Any further connection requirements stipulated by the network operator must also be observed.

When connecting the heating system, all applicable regulations must also be adhered to.

This unit can be used by children aged 8 and over and by persons with limited physical, sensory or mental aptitude or lack of experience and/or knowledge, providing they are supervised or have been instructed in the safe use of the unit and understand the associated potential dangers.

Children must not play with the device. Cleaning and user maintenance must not be carried out by children without supervision.

CAUTION!

When operating or maintaining a heat pump, the legal requirements of the country where the heat pump is operated apply. Depending on the refrigerant quantity, the heat pump must be inspected for leaks at regular intervals by a certified technician, and these inspections must be recorded.

More information can be found in the accompanying log book.

1.4 Energy-efficient use of the heat pump

By operating this heat pump, you are helping to protect the environment. A prerequisite for energy-efficient operation is the correct design of the heat source system and heating system.

It is particularly important for the efficiency of a heat pump to keep the temperature difference between heating water and heat source as small as possible. For this reason, it is advisable to design the heat source and heating system very carefully. **A temperature difference of approx. one Kelvin (one °C) increases the power consumption by around 2.5 %.** When designing the heating system, it should be borne in mind that special consumers such as e.g. domestic hot water preparation should also be taken into consideration and dimensioned for low temperatures. **Underfloor heating systems (panel heating)** are optimally suited for heat pump use on account of the low flow temperatures (30 °C to 40 °C).

It is important to ensure that the heat exchangers are not contaminated during operation because this increases the temperature difference, in turn reducing the COP.

Correct adjustment of the heat pump manager is also important for energy-efficient use of the heat pump. Further information can be found in the operating instructions of the heat pump manager.

2 Purpose of the heat pump

2.1 Application

The air-to-water heat pump is to be used exclusively for the heating of heating water. It can be used in new or already-existing heating systems.

The heat pump is suitable for mono-energy and bivalent operation down to an external temperature of -22 °C.

Proper defrosting of the evaporator is guaranteed by maintaining a heating water return temperature of more than 22 °C during continuous operation.

The heat pump is not designed for the increased heat consumption required when a building is being dried out. For this reason, the additional heat consumption should be met using special devices provided by the customer. For drying out buildings in autumn or winter, we recommend installing a suitable 2nd heat generator (e.g. electric heating element available as an accessory).

i NOTE

The device is not suitable for operation with a frequency converter.

2.2 Operating principle

Surrounding air is drawn in by the fan and fed through the evaporator (heat exchanger). The evaporator cools the air, i.e. it extracts heat from it. This extracted heat is then transferred to the working medium (refrigerant) in the evaporator.

The heat is brought to a higher temperature level by increasing its pressure with the aid of the electrically driven compressor. It is then transferred to the heating water via the liquefier (heat exchanger).

Electrical energy is used to raise the temperature of the heat in the environment to a higher level. As the energy extracted from the air is transferred to the heating water, this type of device is called an air-to-water heat pump.

The air-to-water heat pump consists of the main components: evaporator, ventilator and expansion valve, as well as the low-noise compressors, the liquefier and the electrical control system.

At low ambient temperatures, humidity accumulates on the evaporator in the form of frost, reducing the transfer of heat. Uneven accumulation during this process does not indicate a fault. The evaporator is defrosted automatically by the heat pump as required. Steam may be emitted from the air outlet depending on the atmospheric conditions.

3 Scope of supply

3.1 Basic device

The heat pump contains the components listed below.

The refrigeration circuit is "hermetically sealed" and contains the fluorinated refrigerant R407C included in the Kyoto protocol. Information on the GWP value and CO₂ equivalent of the refrigerant can be found in the chapter Device information. The refrigerant is CFC-free, non-ozone depleting and non-combustible.

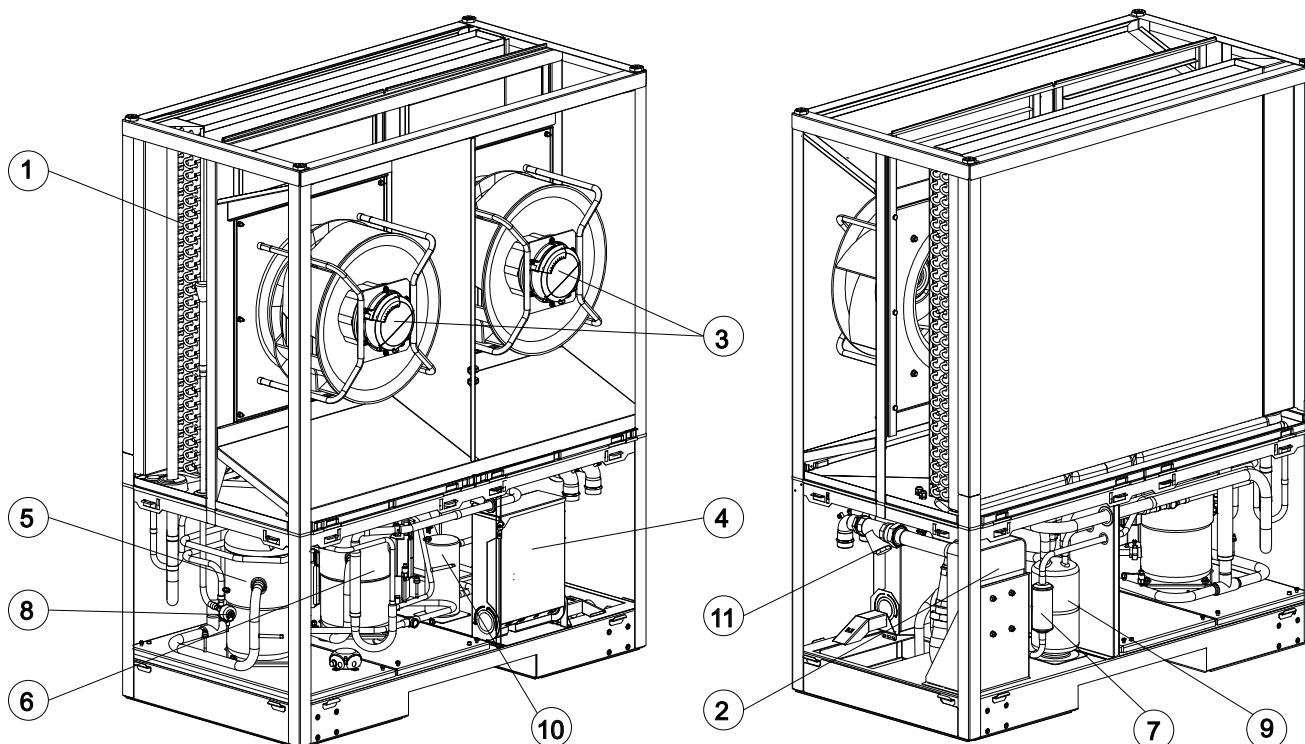

- 1) Evaporator
- 2) Liquefier
- 3) Fan
- 4) Switch box
- 5) Compressor 1
- 6) Compressor 2

- 7) Filter dryer
- 8) Expansion valve
- 9) Inner heat exchanger
- 10) Collector
- 11) Dirt trap

3.2 Switch box

The switch box is located in the heat pump. It can be swung out after removing the lower front cover and loosening the fastening screw located in the upper left-hand corner.

The switch box contains the supply connection terminals as well the power contactors and the soft starter unit.

3.3 Heat pump manager

Use the heat pump manager included in the scope of supply to operate the air-to-water heat pump.

The heat pump manager is a convenient electronic regulation and control device. It controls and monitors the entire heating system based on the external temperature, as well as domestic hot water preparation and safety systems.

The customer must install the external temperature sensor, which is included in the scope of supply of the unit heat pump and heat pump manager together with the necessary fixing accessories.

The enclosed operating instructions describe the function and use of the heat pump manager.

4 Transport

⚠ CAUTION!

When transporting the heat pump, ensure that it is not tilted more than 45° (in any direction).

Transport to the final installation location should be carried out with a pallet. The basic device can be transported with a lift truck or a crane.

The transport eyebolts must be removed after crane transport, and the openings must be closed using the vent plugs supplied.

After transportation, the transport fastening in the device is to be removed from both sides of the base.

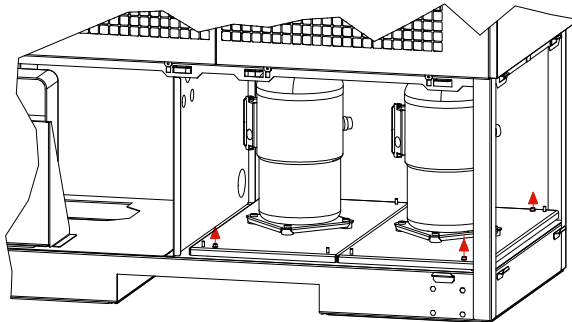

Remove/screw in
transport lock (4x)

⚠ CAUTION!

Before start-up, the transport fastening must be removed.

5 Installation

5.1 General

The device must be installed on a permanently level, smooth and horizontal surface. The frame around the device must lie tightly against the floor to guarantee adequate sound insulation, to prevent water-bearing parts from cooling out and to protect the inside of the device from small animals. If this is not the case, additional insulation measures may be necessary. To prevent small animals from entering the inside of the device, it may be necessary to seal the connection hole in the base plate, for example. Furthermore, the heat pump should be set up so that the air outlet direction of the ventilator is perpendicular to the main wind direction to allow unrestricted defrosting of the evaporator. The heat pump is designed for installation on even ground. If the installation conditions differ (installation on a platform or flat roof) or there is a greater risk of the heat pump tipping over (due to an exposed position or high wind exposure), additional protection against tipping over must be provided. The responsibility for the

heat pump installation lies with the specialist system construction company. During the installation, local requirements such as building regulations, static load of the building, and wind exposure must be accounted for.

It must be possible to carry out maintenance work without hindrance. This is ensured when observing the distances to solid walls as shown in the figure.

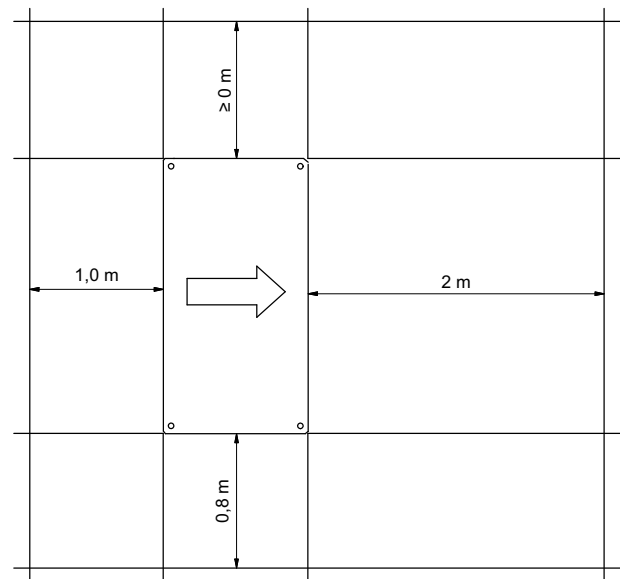

The specified dimensions are valid for stand-alone installation only.

⚠ CAUTION!

Do not restrict or block the area around the air intake or outlet.

⚠ CAUTION!

Observe country-specific building regulations!

⚠ CAUTION!

For installation close to walls the physical influences of the building must be considered. No windows or doors should be present in the area surrounding the air outlet of the ventilator.

⚠ CAUTION!

In cases of installation close to a wall, there may be more sediment in the air inlet and outlet areas due to the air current. The colder outside air outlet should discharge in such a way as to not increase the heat losses in heated neighbouring rooms.

⚠ CAUTION!

Installation in a hollow or in an inner courtyard is not permitted because cooled air collects at ground level and is drawn in again by the heat pump during lengthy operation.

5.2 Condensate pipe

Condensate that forms during operation must be drained off frost-free. To ensure proper drainage, the heat pump must be mounted horizontally. The condensate pipe must have a minimum diameter of 50 mm and must be fed into a sewer in such a way that it is safe from frost. Do not discharge the condensate directly into clearing tanks or cesspits, as aggressive vapours or a condensed water pipe which has not been laid in a frost-free manner could destroy the evaporator.

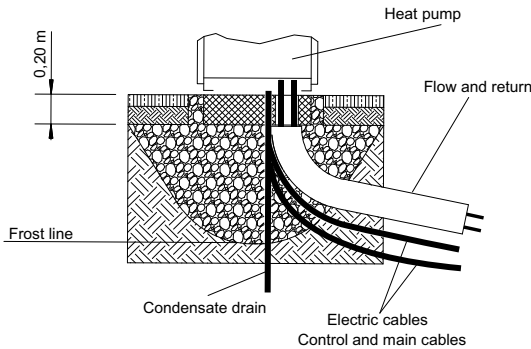
**⚠ CAUTION!**

The frost line can vary according to the climatic region. The regulations of the countries in question must be observed.

6 Assembly

6.1 General

The following connections need to be established on the heat pump:

- Heating system flows and returns
- Condensate outflow
- Control line to the heat pump manager
- Voltage supply

6.2 Connection on heating side

The heating system connections on the heat pump are to be made inside the device. Refer to the device information for the connection sizes. Route the connection hoses out of the device in a downwards direction. An optional pipe kit is available as an accessory, which can be used to lead the connections out to the side.

Use a spanner to firmly grip the transitions when connecting the heat pump.

Before connecting the heating water system to the heat pump, the heating system must be flushed to remove any impurities, residue from sealants, etc. Any accumulation of deposits in the liquefier could cause the heat pump to completely break down.

Once the heat pump has been connected to the heating system, it must be filled, de-aerated and pressure-tested.

Consideration must be given to the following when filling the system:

- Untreated filling water and make-up water must be of drinking water quality (colourless, clear, free from sediments)
- Filling water and make-up water must be pre-filtered (pore size max. 5 µm).

Scale formation in domestic hot water heating systems cannot be avoided, but in systems with flow temperatures below 60 °C, the problem can be disregarded. With high-temperature heat pumps and in particular with bivalent systems in the higher performance range (heat pump + boiler combination), flow temperatures of 60 °C and more can be achieved. The following standard values should therefore be adhered to with regard to the filling and make-up water according to VDI 2035, sheet 1: The total hardness values can be found in the table.

Total heat output in kW	Total alkaline earths in mol/m ³ and/or mmol/l	Specific system volume (VDI 2035) in l/kW		
		< 20	≥ 20 < 50	≥ 50
< 50	≤ 2,0	≤ 16,8	≤ 11,2	≤ 0,11 ¹
50 - 200	≤ 2,0	≤ 11,2	≤ 8,4	
200 - 600	≤ 1,5	≤ 8,4	< 0,11 ¹	
> 600	< 0,02	< 0,11 ¹	< 0,11 ¹	

1. This value lies outside the permissible value for heat exchangers in heat pumps.

Fig. 6.1: Guideline values for filling and make-up water in accordance with VDI 2035

For systems with an above-average specific system volume of 50 l/kW, VDI 2035 recommends using fully demineralized water and a pH stabiliser to minimize the risk of corrosion in the heat pump and the heating system.

⚠ CAUTION!

With fully demineralized water, it is important to ensure that the minimum permissible pH value of 7.5 (minimum permissible value for copper) is complied with. Failure to comply with this value can result in the heat pump being destroyed.

Note:

The hot water connections must be established according to the dimensional drawing (see Cap. 1.1 on page II) in the counter-current principle.

Important:

The notes/settings in the instructions of the heat pump manager must always be observed and carried out accordingly; not doing so will lead to malfunctions.

Minimum heating water flow

The minimum heating water flow rate through the heat pump must be assured in all operating states of the heating system. This can be accomplished, for example, by installing either a dual differential pressureless manifold or an overflow valve. The procedure for setting an overflow valve is described in the chapter "Start-up". When the minimum heating water flow rate is undershot, the plate heat exchanger in the refrigeration circuit can freeze, which can lead to total loss of the heat pump.

The nominal flow rate is specified depending on the max. flow temperature in the device information and must be taken into account during planning. With design temperatures below 30 °C in the flow, the design must be based on the max. volume flow with 5 K spread for A7/W35.

The specified nominal flow rate (See "Device information" on page 10.) must be guaranteed in every operating status. An installed flow rate switch is used only for switching off the heat pump in the event of an unusual and abrupt drop in the heating water flow rate and not to monitor and safeguard the nominal flow rate.

Antifreeze

Heat pump systems, which cannot be guaranteed to be frost-free, should be equipped with a drainage option (see Fig.). The antifreeze function of the heat pump manager is active whenever the heat pump manager and the heat circulating pump are ready for operation. When decommissioning the heat pump, or in the event of a power failure, the system must be drained through the indicated points (see illustration); it may be necessary to purge the system with compressed air. The heating circuit should be operated with a suitable antifreeze if heat pump systems are implemented in buildings where a power failure cannot be detected (holiday home).

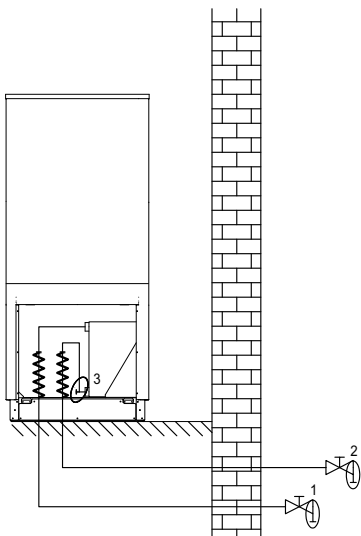

6.3 Electrical connection

3 lines/cables must be routed to the heat pump in total:

- A standard 5-core cable is used to connect the heat pump to the power supply.

The cable must be provided on-site. The conductor cross section is selected in accordance with the power consumption of the heat pump (see attachment Device Information) and the applicable VDE (EN) and VNB regulations. An all-pole disconnecting device with a contact gap of at least 3 mm (e.g. utility blocking contactor or power contactor) must be installed in the heat pump power supply. A 3-pole circuit breaker with joint tripping of all outer conductors (trip current in accordance with device information) provides the short circuit protection taking into account the layout of the internal wiring.

The relevant components in the heat pump contain an internal overload protection.

When connecting, ensure that the incoming supply has a clockwise rotating field.

Phase sequence: L1, L2, L3.

CAUTION!

Ensure that there is a clockwise rotating field: With incorrect wiring the starting of the heat pump is prevented. A corresponding warning is indicated on the display of the heat pump manager (adjust wiring).

- The control voltage is supplied via the heat pump manager. A 3-pole line must be laid for this in accordance with the electrical documentation. Further information on the wiring of the heat pump manager is available in the heat pump manager operating instructions.
- A shielded communication line (J-Y(ST)Y ..LG) (not included in the scope of supply) connects the heat pump manager with the refrigeration circuit control installed in the heat pump. More detailed instructions can be found in the heat pump manager operating instructions and in the electrical documentation.

NOTE

The communication cable is necessary for the function of air-to-water heat pumps in outdoor installation. It must be shielded and laid separately from the mains cable.

6.3.1 Demand sensor connection

The demand sensor R2.2 (NTC 10) is included with the heat pump manager. It must be installed depending on the hydraulics used.

If a demand sensor is not connected, the second heat generator can not be controlled with the heat pump manager in the event of an interruption in communication either.

NOTE

The return sensor R2 installed in the heat pump is active when the compressor is running and must not be disconnected.

7 Start-up

7.1 General

To ensure that start-up is performed correctly, it should only be carried out by an after-sales service technician authorised by the manufacturer. These measures can also include an additional warranty under certain conditions (see Warranty).

7.2 Preparation

The following items need to be checked prior to start-up:

- All of the heat pump connections must be installed as described in chapter 6.
- All valves that could impair the proper flow of the heating water in the heating circuit must be open.
- The air intake and air outlet paths must be clear.
- The fan must turn in the direction indicated by the arrow.
- The settings of the heat pump manager must be adapted to the heating system in accordance with the manager's operating instructions.
- Ensure the condensate outflow functions properly.

7.3 Procedure

The heat pump is started up via the heat pump manager. Adjustments should be made in compliance with the instructions.

At hot water temperatures under 7 °C, start-up is not possible. The water in the buffer tank must be heated to a minimum of 22 °C with the second heat generator.

To ensure a problem-free start-up, the following procedure is to be implemented:

- 1) Close all consumer circuits.
- 2) Ensure that the heat pump has the correct water flow.
- 3) Use the manager to select the automatic operating mode.
- 4) In the special functions menu, start the "Start-up" program.
- 5) Wait until a return temperature of at least 29 °C has been reached.
- 6) Now slowly reopen the heating circuit valves in succession so that the heating water flow is constantly raised by slightly opening the respective heating circuit. The heating water temperature in the buffer tank must not be allowed to drop below 24 °C during this process. This ensures that the heat pump can be defrosted at any time.
- 7) When all heat circuits are fully open and a return temperature of at least 22 °C is maintained, the heat pump start-up is complete.

⚠ CAUTION!

Operating the heat pump at low system temperatures may cause the heat pump to break down completely.

8 Cleaning / maintenance

8.1 Maintenance

To protect the paintwork, avoid leaning anything against the device or putting objects on the device. External heat pump parts can be wiped with a damp cloth and domestic cleaner.

i NOTE

Never use cleaning agents containing sand, soda, acid or chloride as these can damage the surfaces.

To prevent faults due to sediment in the heat exchanger of the heat pump, ensure that the heat exchanger in the heating system cannot be contaminated. In the event that operating malfunctions due to contamination still occur, the system should be cleaned as described below.

8.2 Cleaning the heating system

⚠ CAUTION!

The installed dirt traps must be cleaned at regular intervals.

The maintenance intervals should be defined according to the degree of soiling in the system. The filter insert should also be cleaned.

For cleaning, the heating circuit must be made pressureless in the vicinity of the dirt trap, the filter compartment unscrewed, and the filter insert removed and cleaned. Assembly carried out in reverse order requires attention to correct assembly of the screen inserts and tightness of the screw joints.

The ingress of oxygen into the heating water circuit may result in the formation of oxidation products (rust), particularly if steel components are used. They enter the heating system via the valves, the circulating pumps and/or plastic pipes. It is therefore essential - in particular with respect to the entire pipework - that only diffusion-resistant materials are used.

i NOTE

We recommend the installation of a suitable corrosion protection system to prevent the formation of deposits (e.g. rust) in the condenser of the heat pump. We recommend equipping diffusion-open heating systems with an electrophysical anti-corrosion system (e.g. ELYSATOR system).

Residue from lubricants and sealants may also contaminate the heating water.

In the case of severe contamination leading to a reduction in the performance of the liquefier in the heat pump, the system must be cleaned by a heating technician.

Based on current knowledge, we recommend carrying out the cleaning with a 5 % phosphoric acid or, if more frequent cleaning is required, with a 5 % formic acid.

In either case, the cleaning fluid should be at room temperature. We recommend flushing the heat exchanger in the direction opposite to the normal flow direction.

To prevent acidic cleaning agents from entering the heating system circuit, we recommend connecting the flushing device directly to the flow and return of the liquefier of the heat pump. It is then important that the system be thoroughly flushed using appropriate neutralising agents to prevent any damage from being caused by cleaning agent residue remaining in the system.

Acids must be used with care and the regulations of the employers' liability insurance associations must be adhered to.

The manufacturer's instructions regarding cleaning agent must be complied with at all times.

8.3 Cleaning the air system

The evaporator, ventilator and condensate outflow should be cleaned of contamination (leaves, twigs, etc.) before each new heating period.

⚠ CAUTION!

Before opening the device, ensure that all circuits are powered down.

To prevent the evaporator and the condensate tray from being damaged, do not use hard or sharp objects when cleaning.

Under extreme weather conditions (e.g. snow drifts), ice may form on the air intake and air outlet grids. If this happens, the ice must be removed in the vicinity of the air intake and air outlet grids to ensure that the minimum air flow is maintained.

To ensure proper drainage from the condensate tray, it must be regularly inspected and cleaned, if necessary.

All panelling can be removed to allow accessing the inside of the device.

The two sash fasteners must be opened for this purpose. The cover must then be slightly tilted forward and lifted off toward the top.

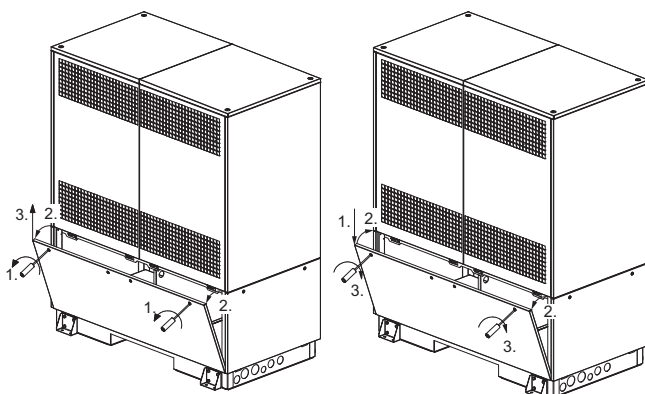

Opening the lower covers

Closing the lower covers

The upper panels are hooked into the cover panel. Loosen the two screws for dismantling and unhook the panels by pulling them back.

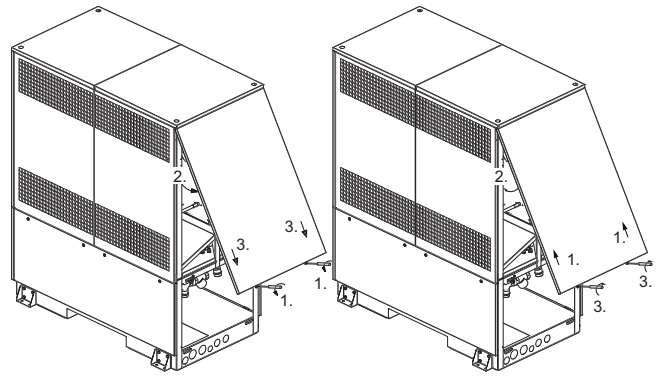

Opening the upper cover panels

Closing the upper cover panels

9 Faults / troubleshooting

This heat pump is a quality product and is designed for trouble-free operation. In the event that a fault should occur, it will be indicated on the heat pump manager display. Simply consult the Faults and Trouble-shooting page in the operating instructions of

the heat pump manager. If you cannot correct the fault yourself, please contact your aftersales service technician.

⚠ CAUTION!

Before opening the device, ensure that all circuits are disconnected from the power supply!

After disconnecting the power supply, always wait for at least 5 minutes to allow stored electric charges to dissipate.

⚠ CAUTION!

Any work on the heat pump may only be performed by authorised and qualified after-sales service technicians.

10 Decommissioning / disposal

Before removing the heat pump, disconnect it from the power source and close all valves. The deinstallation of the heat pump must be performed by technical personnel. Observe all environmentally-relevant requirements regarding the recovery, recycling and disposal of materials and components in accordance with all applicable standards. Particular attention should be paid to the proper disposal of refrigerants and refrigerant oils.

11 Device information

1	Type and order code		LA 60S-TU
2	Design		
	Heat source		Air
2.1	Version		Universal
2.2	Controller		WPM wall-mounted
2.3	Thermal energy metering		Integrated
2.4	Installation location		Outside
2.5	Performance level		2
3	Operating limits		
3.1	Heating water flow / return ¹	°C	to 60 -2(to 62 -2) ² / from 22
	Air (heating)	°C	-22 to +40
4	Flow / sound		
4.1	Heating water flow rate / internal pressure differential		
	A7/W35/30	m ³ /h / Pa	6.0 / 18000
	A7/W45/40	m ³ /h / Pa	5.8 / 16800
	Minimum heating water flow rate A7/W55/47	m ³ /h / Pa	3.4 / 9400
4.2	Sound power level according to EN 12102 Normal operation / reduced operation ³	dB(A)	72 / 66
4.3	Sound pressure level at a distance of 10 m (air outlet side) ⁴ Normal operation / reduced operation ³	dB(A)	44 / 38
4.4	Air flow (controlling range EC fan)	m ³ /h	0 - 25000
5	Dimensions, weight and filling quantities		
5.1	Device dimensions without connections ⁵	H x W x L mm	2300 x 1900 x 1000
5.2	Weight of the transportable unit(s) incl. packaging	kg	870
5.3	Device connections for heating	Inches	Rp 2"
5.4	Refrigerant / total filling weight	Type / kg	R407C / 15.7
5.5	GWP value / CO ₂ equivalent	--- / t	1774 / 27
5.6	Refrigeration circuit hermetically sealed		yes
5.7	Lubricant / total filling quantity	Type / litres	POE (RL32-3MAF) / 8.0
5.8	Volume of heating (cooling) water in device	Litres	10.4
6	Electrical connection		
6.1	Supply voltage / fusing / RCD type		3~/PE 400 V (50 Hz) / C50A / B
6.2	Control voltage / fusing for WPM		1~/N/PE 230 V (50 Hz) / 6.3 AT
6.3	Degree of protection according to EN 60 529		IP24
6.4	Starting current limiter		Soft starter
6.5	Rotary field monitoring		Yes
6.6	Starting current	A	60
6.7	Nominal power consumption A7/W35 / max. consumption ⁶	kW	7.8 / 26.4
6.8	Nominal current with A7/W35 / cos φ	A / ---	14.2 / 0.80
6.9	Power consumption of compressor protection (per compressor)	W	120
6.10	Power consumption of fan	kW	up to 3.9
7	Complies with the European safety regulations		See CE declaration of conformity

8 Additional model features			
8.1	Type of defrosting (according to need)	Reverse circulation	
8.2	Condensate tray frost protection / Water in device protected against freezing ⁷	Heated / Yes	
8.3	max. operating overpressure (heat source / heat sink)	bar	3.0
9 Performance / coefficient of performance (COP)			
9.1	SCOP (Seasonal coefficient of performance) average climate 35 °C / 55 °C	3,91 / 3,33	
9.2	η_s average climate 35 °C / 55 °C	154 / 130	
9.3	Heat output / coefficient of performance (COP) ⁶ Heat source / heat sink	EN 14511	
	Air / water	Performance level	
			1
			2
	with A-15 / W35	kW / ---	16.9 / 2.6
	with A-7 / W35	kW / ---	22.2 / 3.2
	with A2 / W35	kW / ---	26.6 / 3.6
	with A7 / W35-30	kW / ---	35.3 / 4.5
	with A12 / W35	kW / ---	38.1 / 4.8
	with A7 / W45-40	kW / ---	32.9 / 3.7
	with A7 / W55-47	kW / ---	31.7 / 3.2

1. For air temperatures between -22 °C and 0 °C, flow temperature increasing from 45 °C to 60 °C.
2. The specified maximum heating water flow temperature applies to a set minimum heating water flow.
3. The heat output and COP is reduced by approx. 5% in lower operation
4. The specified sound pressure level corresponds to the operating noise of the heat pump in heating operation with a flow temperature of 55 °C. The specified sound pressure level represents the free sound area level. The measured value can deviate by up to 16 dB(A) depending on the installation location.
5. Note that additional space is required for pipe connections, operation and maintenance
6. This data indicates the size and capacity of the system. For an analysis of the economic and energy efficiency of the system, the bivalence point and the regulation should be taken into consideration. These figures are only achieved with clean heat exchangers. Instructions for maintenance, commissioning and operation can be found in the relevant sections of the assembly and operating instructions. The specified values have the following meaning, e.g. A 7 / W35: heat source temperature 7 °C and heating water flow temperature 35 °C.
7. The heat circulating pump and the heat pump manager must always be ready for operation.

12 Product information as per Regulation (EU) No 813/2013, Annex II, Table 2

Information requirements for heat pump space heaters and heat pump combination heaters				Glen Dimplex Deutschland		Dimplex	
Model	LA 60S-TU						
Air-to-water heat pump	yes						
Water-to-water heat pump	no						
Brine-to-water heat pump	no						
Low-temperature heat pump	no						
Equipped with a supplementary heater	no						
Heat pump combination heater	no						
Parameters shall be declared for medium-temperature application, except for low-temperature heat pumps. For low-temperature heat pumps, parameters shall be declared for low-temperature application.							
Parameters shall be declared for average climate conditions:							
Item	Symbol	Value	Unit	Item	Symbol	Value	Unit
Rated heat output (*)	Prated	35	kW	Seasonal space heating energy efficiency	η_s	130	%
Declared capacity for heating four part load at indoor temperature 20°C and outdoor temperature T_j				Declared coefficient of performance or primary energy ratio for part load at indoor temperature 20 °C and outdoor temperature T_j			
$T_j = -7^\circ\text{C}$	P_{dh}	39,0	kW	$T_j = -7^\circ\text{C}$	COP_d	2,41	-
$T_j = +2^\circ\text{C}$	P_{dh}	26,4	kW	$T_j = +2^\circ\text{C}$	COP_d	3,30	-
$T_j = +7^\circ\text{C}$	P_{dh}	33,8	kW	$T_j = +7^\circ\text{C}$	COP_d	4,19	-
$T_j = +12^\circ\text{C}$	P_{dh}	39,7	kW	$T_j = +12^\circ\text{C}$	COP_d	4,76	-
$T_j = \text{bivalent temperature}$	P_{dh}	36,0	kW	$T_j = \text{bivalent temperature}$	COP_d	2,22	-
$T_j = \text{operation limit temperature}$	P_{dh}	36,0	kW	$T_j = \text{operation limit temperature}$	COP_d	2,22	-
For air-to-water heat pumps				For air-to-water heat pumps:			
$T_j = -15^\circ\text{C}$ (if TOL < -20°C)	P_{dh}	0,0	kW	$T_j = -15^\circ\text{C}$ (if TOL < -20°C)	COP_d	0,00	-
Bivalent temperature	T_{biv}	-10	°C	For air-to-water heat pumps:			
				Operation limit temperature	TOL	-10	°C
Cycling interval capacity for heating	P_{cyc}	-	kW	Cycling interval efficiency	COP_{cyc}	-	-
Degradation co-efficient (**)	C_{dh}	0,90	-	Heating water operating limit temperature	WTOL	60	°C
Power consumption in modes other than active mode				Supplementary heater			
Off mode	P_{OFF}	0,030	kW	Rated heat output (*)	P_{sup}	0	kW
Thermostat-off mode	P_{TO}	0,029	kW	Type of energy input	electrical		
Standby mode	P_{SB}	0,030	kW				
Crankcase heater mode	P_{CK}	0,095	kW				
Other items				For air-to-water heat pumps: Rated air flow rate, outdoors			
Capacity control		fixed			-	14000	m ³ /h
Sound power level, indoors/ outdoors	L_{WA}	- / 72	dB	For water-/brine-to-water heat pumps: Rated brine or water flow rate, outdoor heat exchanger	-	--	m ³ /h
Emissions of nitrogen oxides	NO_x	-	mg/kWh				
For heat pump combination heater:							
Declared load profile		-		Water heating energy efficiency	η_{wh}	-	%
Daily electricity consumption	Q_{elec}	-	kWh	Daily fuel consumption	Q_{fuel}	-	kWh
Contact details	Glen Dimplex Deutschland GmbH, Am Goldenen Feld 18, 95326 Kulmbach						
(*) For heat pump space heaters and heat pump combination heaters, the rated output P_{rated} is equal to the design load for heating $P_{designh}$, and the rated heat output of a supplementary capacity for heating $sup(T_j)$.							
(**) If C_{dh} is not determined by measurement then the default degradation is $C_{dh} = 0,9$							
(-) not applicable							

13 Dimension Drawings

13.1 Dimension Drawing

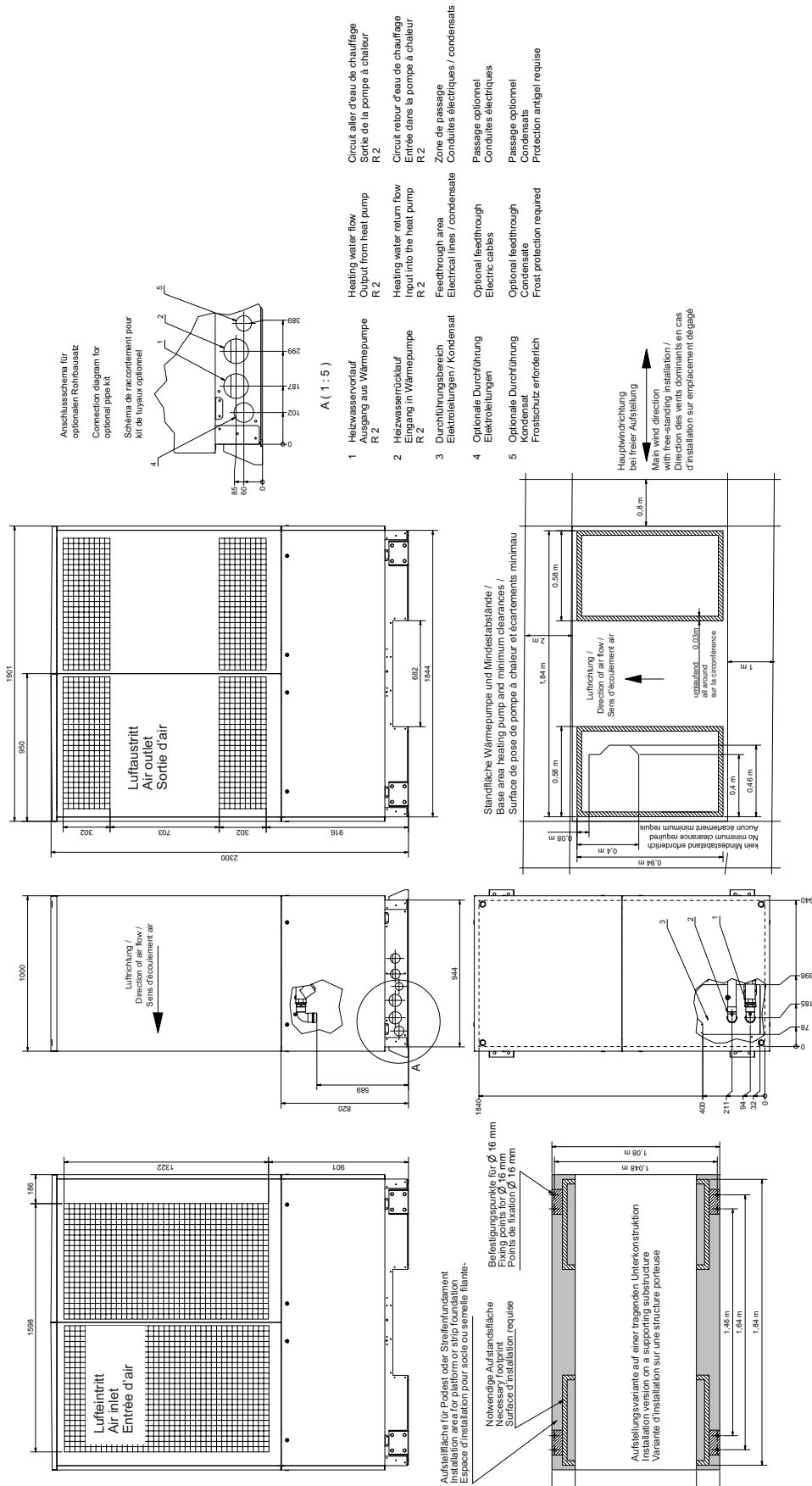

14 Diagrams

14.1 Characteristic curves for heating operation

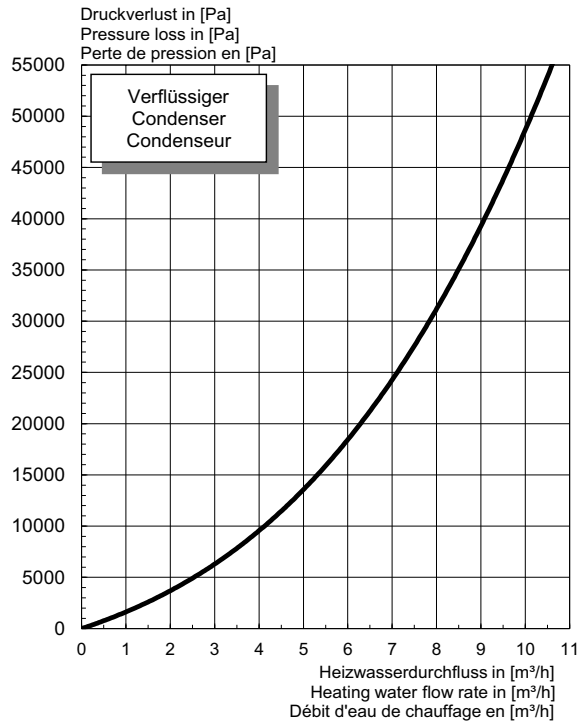
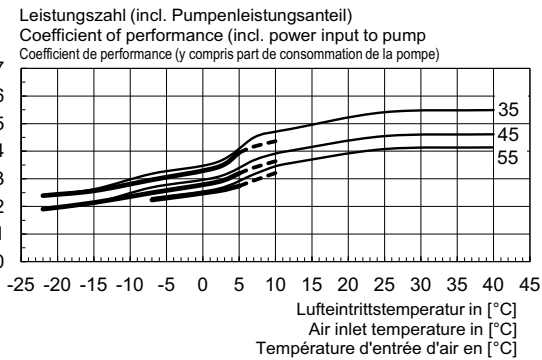
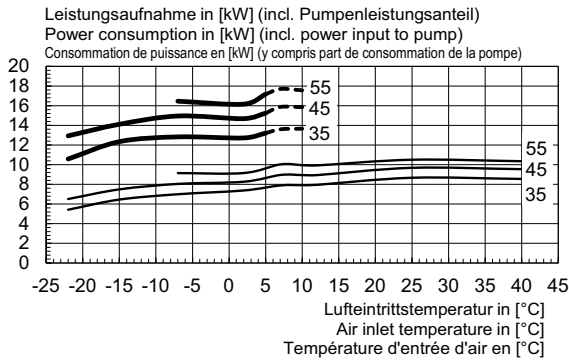
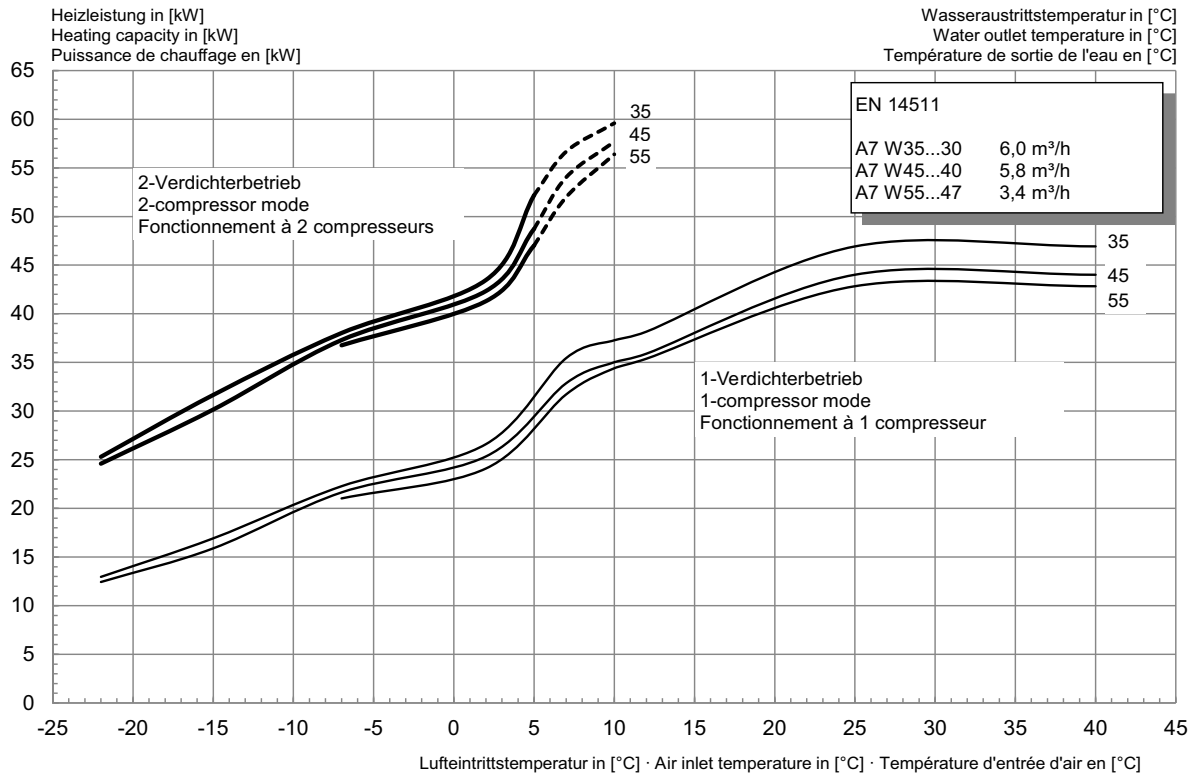

14.2 Operating limits diagram heating

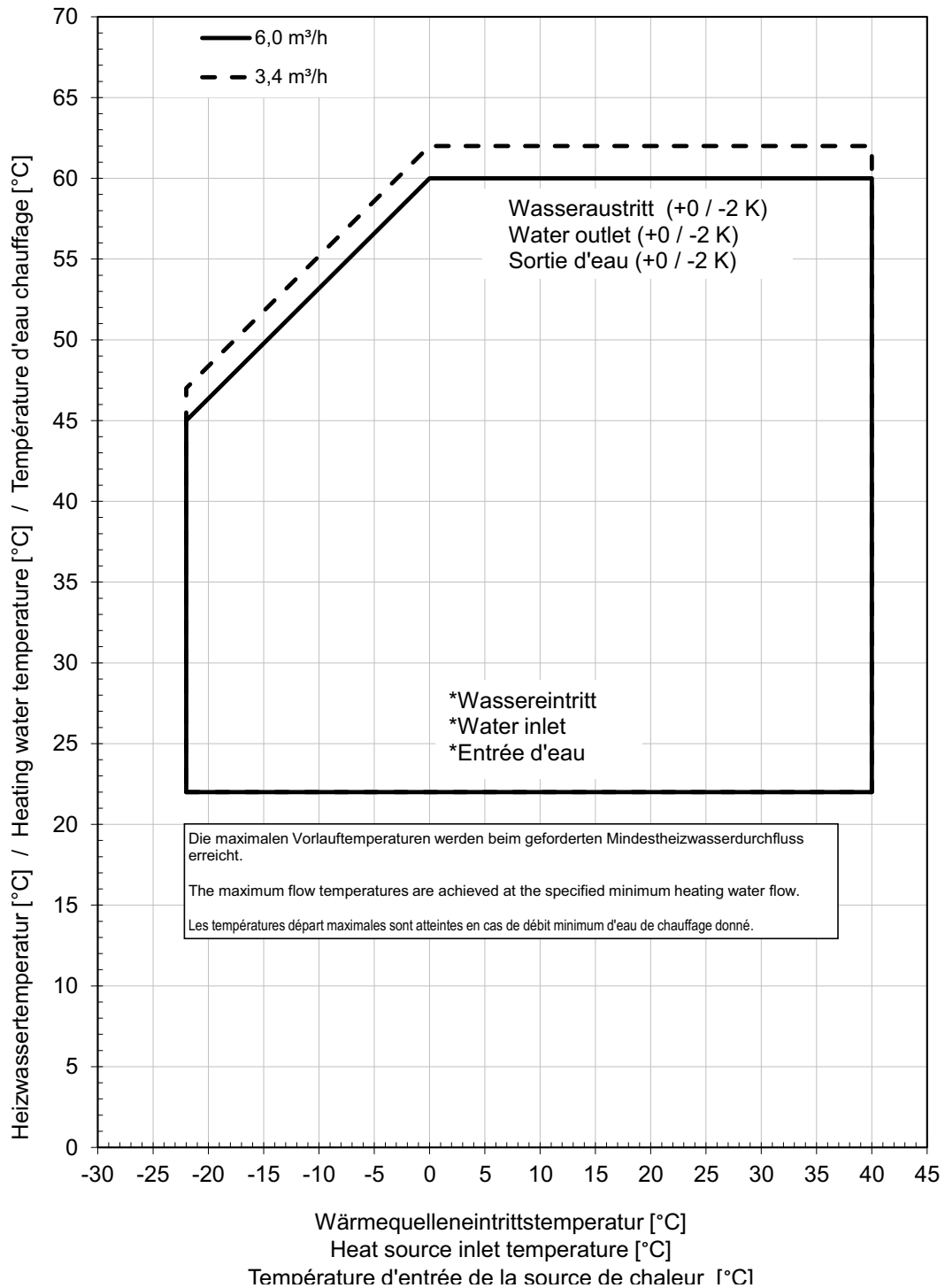







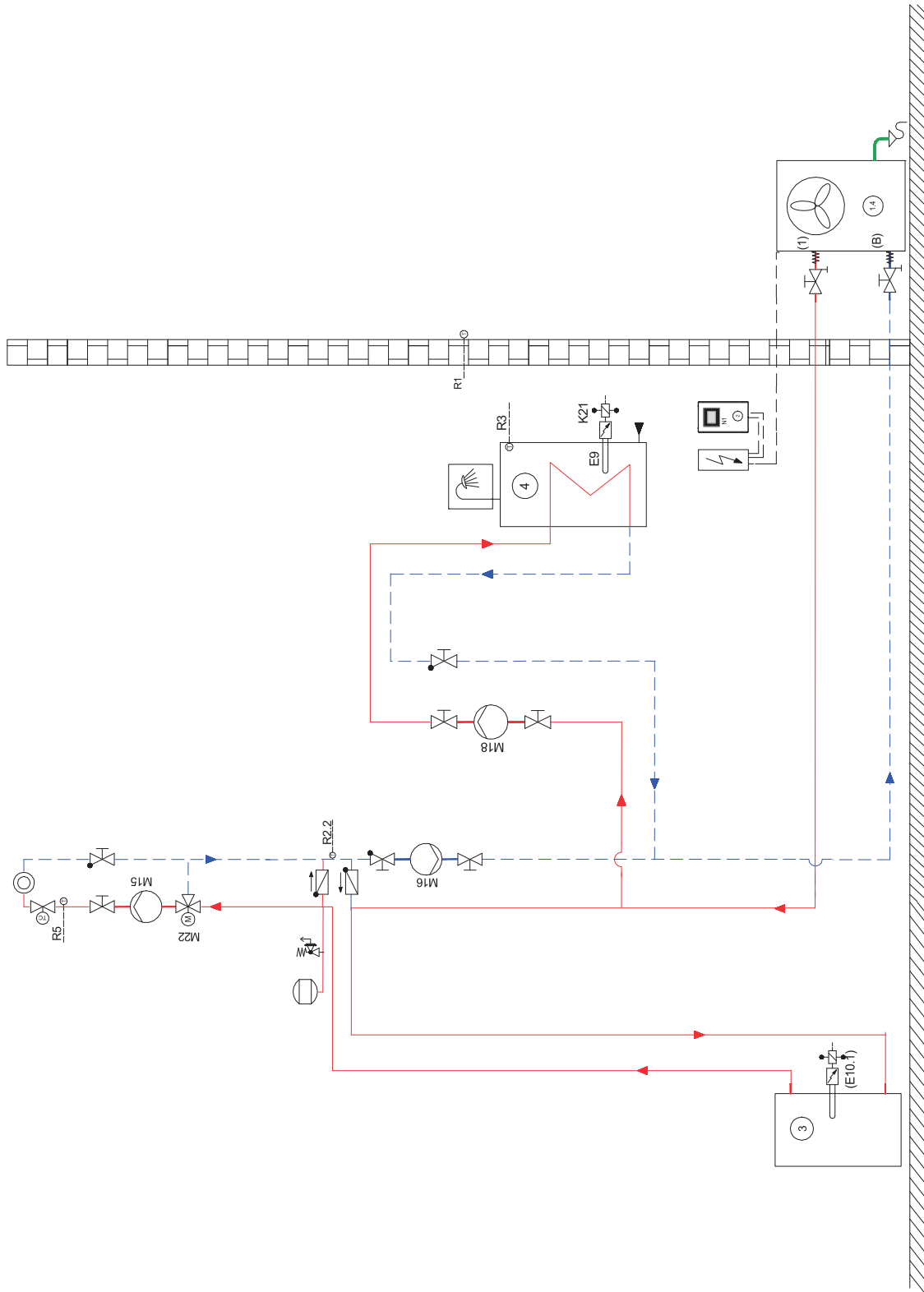









*Bei Luft/Wasser-Wärmepumpen stellt die minimale Heizwassertemperatur die Mindest-Rücklauf-temperatur dar
 *For air-to-water heat pumps the minimum heating water temperature is the minimum return temperature
 *Sur les pompes à chaleur air / eau, la température minimale d'eau de chauffage correspond à la température retour minimale

15 Integration diagram

15.1 Hydraulic integration diagrams



15.2 Legend

	Shut-off valve
	Safety valve combination
	Circulating pump
	Expansion vessel
	Room temperature-controlled valve
	Shut-off valve with check valve
	Shutoff valve with drainage
	Heat consumer
	Four-way reversing valve
	Temperature sensor
	Flexible connection hose
	Check valve
	Three-way mixer
	Air-to-water heat pump
	Heat pump manager
	Buffer tank connected in series
	Hot water cylinder
E9	Flange heater, hot water
E10.1	Immersion heater
K20	Contactors for HG2
K21	Contactors for flange heater
M15	Heat circulating pump for heating circuit 2
M16	auxiliary circulating pump
M18	Hot water loading pump
M22	Mixer for heating circuit 2
N1	Heat pump manager
N3	Room climate control station 1
N4	Room climate control station 2
R1	External wall sensor
R2.2	Demand sensor
R3	Hot water sensor
R5	Temperature sensor for heating circuit 2

16 Declaration of Conformity

You can find and download the current CE conformity declaration at:

<https://glendimplex.de/la60stu>



Glen Dimplex Deutschland

Head office

Glen Dimplex Deutschland GmbH
Am Goldenen Feld 18
D-95326 Kulmbach

T +49 9221 709-100
F +49 9221 709-339
dimplex@glendimplex.de
www.glendimplex.de

Service and technical support

After-sales service, technical support
and spare parts
Assistance before and after installation
of your equipment

T +49 9221 709-545
F +49 9221 709-924545
Mon - Thu: 7:30 to 16:30
Fri: 7:30 to 15:00
service-dimplex@glendimplex.de

Our 24 hr hotline is available
for emergencies outside
normal opening times

Request after-sales service on the internet:
www.glendimplex.de/dienstleistungen-dimplex