

HWK 332HC

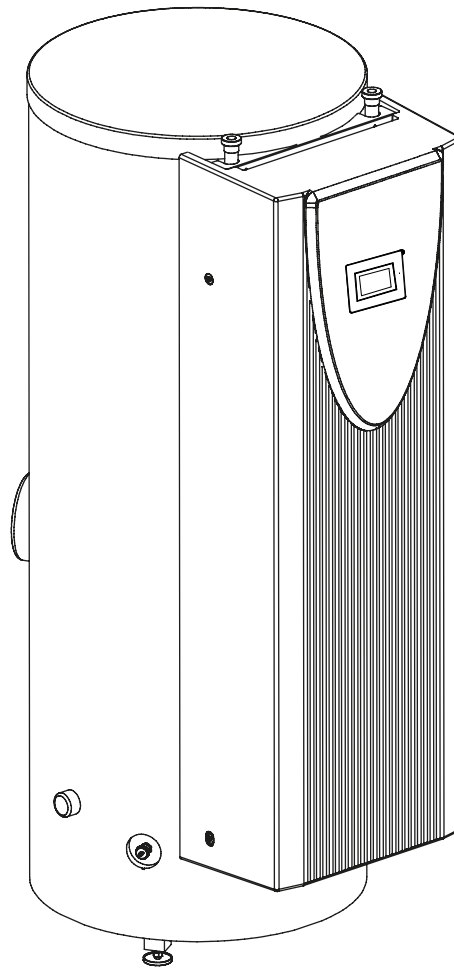

Installation and Operating Instruction

Hydro tower
with HPM

Table of contents

1	Safety notes	EN-2
1.1	Symbols and markings.....	EN-2
1.2	Important information.....	EN-2
1.3	Legal regulations and guidelines.....	EN-2
2	Purpose of the Heat Pump	EN-2
2.1	Application.....	EN-2
2.2	General properties.....	EN-2
3	Scope of supply	EN-3
3.1	Basic device.....	EN-3
3.2	Switch box.....	EN-3
3.3	Heat pump manager.....	EN-3
4	Accessories	EN-3
4.1	Building management technology.....	EN-3
5	Transport	EN-4
6	Installation	EN-4
6.1	General.....	EN-4
6.2	Sound.....	EN-4
7	Assembly	EN-5
7.1	General.....	EN-5
7.2	Heating system connection.....	EN-5
7.3	Temperature sensor.....	EN-5
7.4	Electrical connection.....	EN-7
8	Start-up	EN-7
8.1	General.....	EN-7
8.2	Preparation.....	EN-7
8.3	Procedure.....	EN-7
9	Cleaning / maintenance	EN-8
9.1	Maintenance.....	EN-8
9.2	Cleaning the heating system.....	EN-8
9.3	Corrosion Protection Anode.....	EN-8
10	Faults / troubleshooting	EN-8
11	Decommissioning / disposal	EN-8
12	Device information	EN-9
13	Dimension Drawings	EN-10
13.1	Dimension Drawing.....	EN-10
14	Diagrams	EN-11
14.1	Characteristic curves.....	EN-11
15	Integration diagram	EN-12
15.1	Mono energy heat pump heating system with one heating circuit, buffer tank and hot water cylinder.....	EN-12
15.2	Mono energy heat pump heating system with three heating circuits, buffer tank and hot water cylinder.....	EN-13
15.3	Legend.....	EN-14

1 Safety notes

1.1 Symbols and markings

Particularly important information in these instructions is marked with CAUTION! and NOTE.

⚠ CAUTION!

Immediate danger to life or danger of severe personal injury or significant damage to property.

i NOTE

Risk of damage to property or minor personal injury or important information with no further risk of personal injury or damage to property.

1.2 Important information

The operational reliability of the safety valve should be checked at regular intervals. We recommend having an annual service inspection carried out by a qualified specialist company.

The outflow from the safety valve should visibly flow into a waste water drain.

The installer of the heating system is responsible for checking whether an additional expansion vessel is required.

Operating the system in a sensible way can provide significant energy savings. The heating water temperature should be as low as required during heat pump operation. The planner of the heating system is responsible for determining the system temperature.

When installing an underfloor heating system, a sensible value for the maximum flow and return temperature should be set on the heat pump manager. The position of the temperature sensor is important in this regard.

1.3 Legal regulations and guidelines

This heat pump is designed for use in a domestic environment according to Article 1, Paragraph 2 k) of EU directive 2006/42/EU (machinery directive) and is thus subject to the requirements of EU directive 2014/35/EU (low-voltage directive). It is thus also intended for use by non-professionals for heating shops, offices and other similar working environments, in agricultural establishments and in hotels, guest houses and similar / other residential buildings.

The construction and design of the hydro tower complies with all relevant EU directives, DIN and VDE regulations (see CE declaration of conformity).

When connecting the hydro tower to the power supply, the relevant VDE, EN and IEC standards must be fulfilled. Any further connection requirements stipulated by the mains supply network operator must also be observed.

When connecting the heating system, all applicable regulations must also be adhered to.

The current valid regulations must be complied with when connecting the heating system. The local regulations for the drinking water supply must also be complied with when connecting the device to the drinking water supply.

This unit can be used by children aged 8 and over and by persons with limited physical, sensory or mental aptitude or lack of experience and/or knowledge, providing they are supervised or

have been instructed in the safe use of the unit and understand the associated potential dangers.

Children must not play with the device. Cleaning and user maintenance must not be carried out by children without supervision.

2 Purpose of the Heat Pump

2.1 Application

The hydro tower constitutes the interface between a non-reversible heat pump and the heat distribution in the building. The hydro tower contains all hydraulic components required between heat generation and heat distribution with an unmixed heating circuit. A dual differential pressureless manifold with a buffer tank allows an energy-optimised hydraulic integration of the heat generator and the heat distribution.

i NOTE

The device is not suitable for operation with a frequency converter.

2.2 General properties

- Low installation effort
- All components easily accessible
- Ready-to-connect, contains all essential components, i.e. pumps, shut-offs, safety devices and heat pump manager
- Integrated 300l hot water cylinder
- Integrated buffer tank reduces operating cycles of the heat pump, thus increasing the efficiency of the system
- The infinitely adjustable operation of the circulating pump in the heating circuit allows the output to be adjusted according to need.
- Optional immersion heater up to 6 kW
- Switchable pipe heater (2 / 4 / 6 kW) for supplementary heating.

3 Scope of supply

3.1 Basic device

Hydraulic components

- Dual differential pressureless manifold
- Buffer tank, 100 litres
- Unmixed heating circuit incl. circulating pump (self-regulating - 3/4 stages), shut-offs and back-pressure feature
- Primary circuit heat generation incl. circulating pump (PWM input signal), shut-offs
- 2nd heat generator, electrical pipe heater, heat output 2 / 4 / 6 kW, secured via safety temperature limiter
- 300 litre domestic hot water cylinder incl. domestic hot water circulating pump

Safety equipment:

- Safety valve, start-to-leak pressure 3.0 bar
- An additional expansion vessel can be connected

3.2 Switch box

⚠ CAUTION!

Before opening the device, ensure that all circuits are powered down.

The switch box is located in the upper area of the hydro tower. After removing the front cover, the switch box is freely accessible.

The switch box contains the supply connection terminals, heating contactors, Bus connections (connecting line to the heat pump) and the heat pump manager (WPM OEM).

3.3 Heat pump manager

The integrated heat pump manager (WPM OEM) is a convenient electronic regulation and control device. It controls and monitors the entire heating system based on the external temperature, as well as domestic hot water preparation and safety systems.

The external temperature sensor (to be connected on site) including the fixing accessories, is included in the scope of supply of the heat pump manager.

The enclosed operating instructions describe the function and use of the heat pump manager.

4 Accessories

4.1 Building management technology

The heat pump manager can be connected to a building management system network via supplementation of the relevant interface plug-in card. The supplementary installation instructions of the interface card must be consulted regarding the exact connection and parameterisation of the interface.

The following network connections can be made on the heat pump manager:

- Modbus
- EIB, KNX
- Ethernet

⚠ CAUTION!

If the heat pump or circulating pumps are controlled externally, a flow rate switch is required to prevent the compressor from being switched on when there is no volume flow.

5 Transport

A pallet should be used to transport the heat pump to its final installation location. The basic device can be transported with a lift truck, a pushcart or similar.

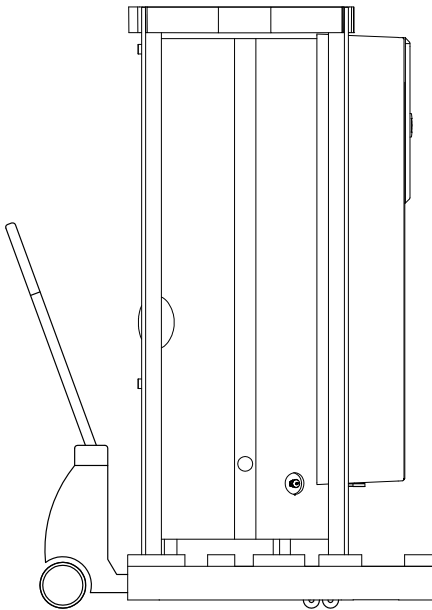

⚠ CAUTION!
The hydro tower is to be fixed to the transport pallet with screws.

6 Installation

6.1 General

The unit should always be installed indoors on a level, smooth and horizontal surface. The hydro tower must be installed in such a way that maintenance work can be carried out from the operating side without hindrance. This can be ensured by maintaining a clearance of 1 m at the front. The space required (approx. 30 cm, see dimension drawing) for replacing the protective anode must be taken into consideration when determining the required height of the installation room. It must be installed in a room protected from frost and with short pipe runs.

Setup and installation must be performed by an authorised specialist company.

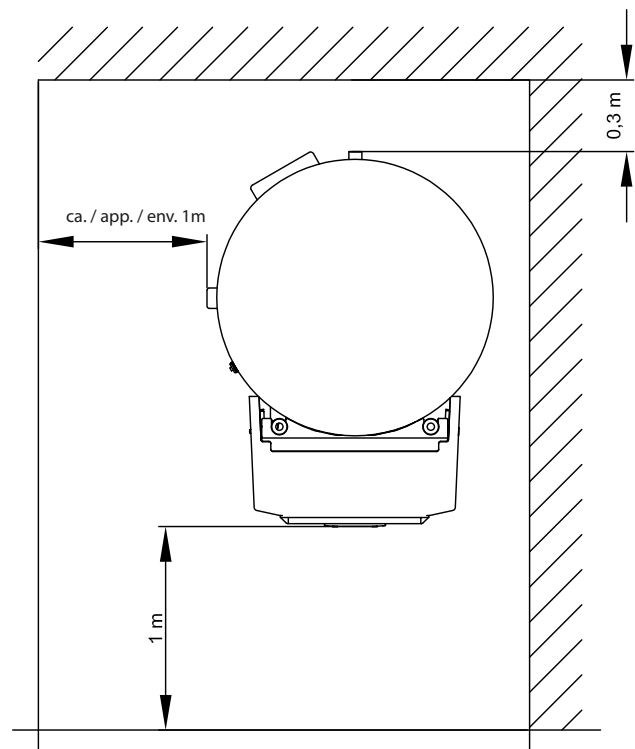

If the hydro tower is installed on an upper floor, the load-bearing capacity of the ceiling should be checked. On account of the acoustics, measures for isolating possible vibrations should also be very carefully planned. Installation on floors above wooden ceilings is not recommended.

i NOTE

The heat pump is not intended for use over 2000 metres above sea level.

6.2 Sound

To prevent solid-borne sound from being transmitted to the heating system, we recommend connecting the heat pump circuit to the hydro tower using a flexible hose.

7 Assembly

7.1 General

The following connections need to be made on the hydro tower

- Flow / return of the heat pump
- Flow / return of the heating system
- Safety valve outflow
- Voltage supply
- Hot water pipe
- Circulation pipe
- Cold water pipe

i NOTE

When removing the unit cover, it must be taken into account that the length of the connecting cable between the control panel in the unit cover and the controller on the contact plate is only 1.5 m. If the device cover can only be placed further away than this when it has been removed, the plug connection on the controller or on the control panel must first be disconnected.

7.2 Heating system connection

The heating system connections on the hydro tower have a 1 1/4" flat-sealing external thread. A spanner must be used to firmly grip the transitions when making the connections.

A dimensionally stable 3/4" plastic hose (inner diameter approx. 19 mm) must be affixed to the hose nozzle, e.g. with a pipe clamp, and guided outside the building in the area behind the heat pump return.

Before the heating water system is connected, it must be flushed to remove any impurities, residue from sealants, etc. Any accumulation of deposits in the liquefier may cause the heat pump to completely break down. For systems in which the heating water flow can be shut off via radiator or thermostat valves, the infinitely adjustable circulating pump carries out a demand-related adjustment of the delivery height. The initial filling and start-up must be carried out by an authorised specialist company. The entire system, including all factory-assembled components, should be inspected to ensure that everything is working properly and that there is no leakage.

The buffer tank and heating system must be filled via the filling and drain cock on the hydro tower. The cylinder must be de-aerated using the air-relief cock on the upper pipe connection to the cylinder.

The isolation ball valve above the heat circulating pump (M13) is equipped with a check valve with an "air lock". This makes it possible for air to escape from the HWK's pipe system via the check valve and into the connected heating circuit when the ball valve is open. A suitable means of de-aeration must also be installed in the heating circuit on site.

It is additionally recommended that an isolation device be installed in the heating return before integration into the HWK is carried out. This isolation device should prevent excessive heating water loss if it becomes necessary to replace the "auxiliary circulating pump" (M16).

If it is necessary to connect heating connection pipes to the rear of the cylinder, these can also be laid underneath the cylinder.

It is possible to connect a second or third heating circuit (accessory component "Manifold bar VTB). For this extension to be

made, the heat circulating pump (M13) in the HWK must be removed and replaced with a suitable adaptor (inner micrometer 180 mm).

The following pre-wired heating circuit modules (heating or heating/cooling (C)) can be connected to the HWK 332HC:

- Unmixed heating circuits: MHU(C) 25 with pump
- Mixed heating circuits:MHM(C) 25 with pump
- MHMC 25Flex without pump with fitting piece 180 mm

The installation of the heating circuits then takes place on-site outside the HWK.

The condensate tray installed as standard means that the Hydro-tower can also be used for cooling.

In this case, a drain hose must be installed on the tray.

i NOTE

If the pipes are more than 10 m long, the free compression values stated in the device information must be observed (minimum pipe diameter for volume flows of more than 1.5 m³/h: DN 32)

Minimum heating water flow

The minimum heating water flow of the heat pump is ensured by the dual differential pressureless manifold in all operating states of the heating system.

A method of manual drainage must be provided for heat pumps which are exposed to frost. The frost protection function of the Heat pump manager is active whenever the heat pump manager and the heat circulating pump are ready for operation. The system has to be drained if the heat pump is taken out of service or if a power failure occurs. The hydraulic network should be operated with suitable frost protection if heat pump systems are implemented in buildings where a power failure cannot be detected (vacation homes etc.).

7.3 Temperature sensor

7.3.1 Hydro tower HWK 332HC

The following temperature sensors are already installed or must be installed additionally:

- External temperature sensor (R1) supplied (NTC-2)
- Return temperature (R2.1) installed (NTC-10)
- Domestic hot water temperature (R3) installed (NTC-10)

7.3.2 Sensor characteristic curves

Temperature in °C		-20	-15	-10	-5	0	5	10	
NTC-2 in kΩ		14.6	11.4	8.9	7.1	5.6	4.5	3.7	
NTC-10 in kΩ		67.7	53.4	42.3	33.9	27.3	22.1	18.0	
15	20	25	30	35	40	45	50	55	60
2.9	2.4	2.0	1.7	1.4	1.1	1.0	0.8	0.7	0.6
14.9	12.1	10.0	8.4	7.0	5.9	5.0	4.2	3.6	3.1

The temperature sensors to be connected to the heat pump manager must correspond to the sensor characteristic curve illustrated in Fig. 7.1 on page 6. The only exception is the external temperature sensor included in the scope of supply of the heat pump (see Fig. 7.2 on page 6)

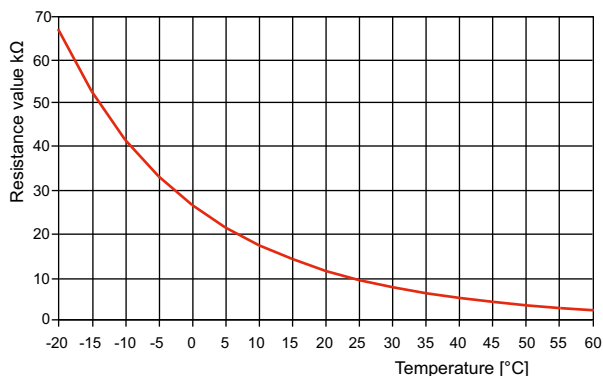

Fig. 7.1:Sensor characteristic curve NTC-10

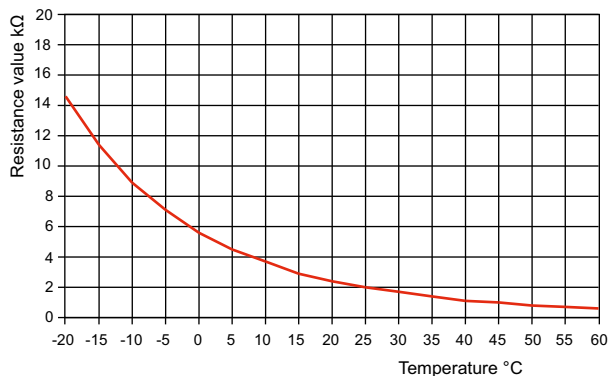

Fig. 7.2:Sensor characteristic curve, NTC-2 according to DIN 44574 External temperature sensor

7.3.3 Mounting the external temperature sensor

The temperature sensor must be mounted in such a way that all weather conditions are taken into consideration and the measured value is not falsified.

- Mount on the external wall on the north or north-west side where possible
- Do not install in a “sheltered position” (e.g. in a wall niche or under a balcony)
- Not in the vicinity of windows, doors, exhaust air vents, external lighting or heat pumps
- Not to be exposed to direct sunlight at any time of year

Dimensioning parameter sensor lead	
Conductor material	Cu
Cable-length	50 m
Ambient temperature	35 °C
Laying system	B2 (DIN VDE 0298-4 / IEC 60364-5-52)
External diameter	4-8 mm

7.3.4 Installing the strap-on sensor

It is only necessary to mount the strap-on sensors if they are included in the scope of supply of the heat pump but have not yet been installed.

The strap-on sensors can be fitted as pipe-mounted sensors or installed in the immersion sleeve of the compact manifold.

Mounting as a pipe-mounted sensor

- Remove paint, rust and scale from heating pipe.
- Coat the cleaned surface with heat transfer compound (apply sparingly).
- Attach the sensor with a hose clip (tighten firmly, as loose sensors can cause malfunctions) and thermally insulate.

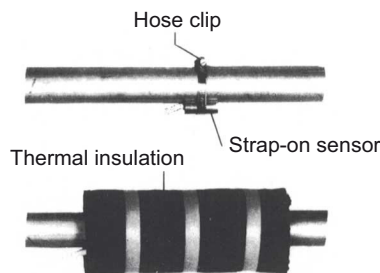

7.3.5 Hydraulic distribution system

The dual differential pressureless manifold functions as an interface between the heat pump, the heating distribution system, the buffer tank and the domestic hot water cylinder. A compact system is used to simplify the installation process, so that a lot of different components do not have to be installed individually. Further information can be found in the relevant installation instructions.

Dual differential pressureless manifold

The return sensor is installed in the immersion sleeve of the dual differential pressureless manifold. The sensor is flowed through in every operating situation (generation and consumer circuit).

7.4 Electrical connection

The power supply and control voltage are supplied using standard cables (load: 3~ 5-core / 1~ 3-core; control 3-core).

For detailed instructions on how to connect the external components and how the heat pump manager functions, please refer to the device electrical documentation.

An all-pole disconnecting device with a contact gap of at least 3 mm (e.g. utility blocking contactor or power contactor) and an all-pole circuit breaker with common tripping for all external conductors must be installed in the power supply for the hydro tower (tripping current in compliance with the device information).

The (L/N/PE~230 V, 50 Hz) supply cable for the heat pump manager must have a constant voltage. For this reason, it should be tapped upstream from the utility blocking contactor or be connected to the household current, as important protection functions could otherwise be lost during a utility block.

The correct control voltage must be ensured according to the general information leaflet.

On delivery, the second heat generator is connected with a 6 kW heat output. To reduce the output to 4 kW or 2 kW, one or both of the two copper link cables must be removed from terminal X1 (see circuit diagram).

For detailed information, see circuit diagrams in the appendix.

The pipe heater (2nd heat generator) must only be connected by authorised electricians according to the corresponding circuit diagram. Regulations of the utility company and national guidelines must be observed (VDE).

If an optional immersion heater (E10.12) is used (with 1½" external thread in the buffer tank), a contactor K20.2 must be used which is suited to the relevant switching capacity. The contactor is installed in the electrical distribution system. The mains cables for the radiators should be dimensioned and protected according to DIN VDE 0100. The immersion heater used must be equipped with an integrated safety temperature limiter.

A cable duct is integrated into the polyurethane foam at the top of the cylinder (under the upper covering cap) which makes it possible to lay the electrical cables under the upper cover (from the rear of the cylinder to the front/connection side).

i NOTE

To use the HWK 332HC, two connecting cables (< 25 V / 230 V) must be routed between the heat pump manager and the heat pump.

i NOTE

Further information on the wiring of the heat pump manager is available in the electrical documentation.

⚠ CAUTION!

The communication cable is necessary for the function of air-to-water heat pumps in outdoor installation. It must be shielded and laid separately from the mains cables. It is connected to N1-J25. For further information, see electrical documentation

8 Start-up

8.1 General

To ensure that start-up is performed correctly, it should only be carried out by an after-sales service technician authorised by the manufacturer. This may be a condition for extending the guarantee.

8.2 Preparation

The following items need to be checked prior to start-up:

- All of the hydro tower connections must be installed as described in Cap. 7 on page 5.
- All valves that could impair the proper flow of the heating water in the heating circuit must be open.
- The settings of the heat pump manager must be adapted to the heating system in accordance with the latter's operating instructions.

8.3 Procedure

The hydro tower is started up via the heat pump manager. Settings should be made in compliance with the instructions.

The operating overpressures indicated on the type plate must not be exceeded.

Any faults which occur during operation are also displayed on the heat pump manager. They can be rectified as described in the operating instructions.

9 Cleaning / maintenance

9.1 Maintenance

To protect the cover, avoid leaning anything against the device or putting objects on the device. External parts can be wiped clean with a damp cloth and domestic cleaner.

NOTE

Never use cleaning agents containing sand, soda, acid or chloride, as these can damage the surfaces.

9.2 Cleaning the heating system

The ingress of oxygen into the heating water circuit may result in the formation of oxidation products (rust), particularly if steel components are used. These enter the heating system via the valves, the circulating pumps and/or plastic pipes. A diffusion-resistant installation is therefore essential, especially with regard to the piping of underfloor heating systems.

Residue from lubricants and sealants may also contaminate the heating water.

In the event of severe contamination leading to a reduction in the performance of the liquefier in the heat pump, the system must be cleaned by a heating technician.

Based on current information, we recommend using a 5 % phosphoric acid solution for cleaning purposes. However, if cleaning needs to be performed more frequently, a 5 % formic acid solution should be used.

In either case, the cleaning fluid should be at room temperature. We recommend flushing the heat exchanger in the direction opposite to the normal flow direction.

To prevent acidic cleaning agents from entering the heating system circuit, we recommend connecting the flushing device directly to the flow and return of the liquefier of the heat pump.

It is then important that the system be thoroughly flushed using appropriate neutralising agents to prevent any damage from being caused by cleaning agent residue remaining in the system.

Acids must be used with care, and the regulations of the employers' liability insurance associations adhered to.

The manufacturer's instructions regarding cleaning agent must be complied with at all times.

9.3 Corrosion Protection Anode

The corrosion protection anode installed in the hot water cylinder should be electrically checked on a regular basis, at least every two years after start-up, and be replaced if necessary. Electrical checking is carried out by means of a suitable ammeter, without draining the tank.

Procedure:

- 1) Unplug PE cable from protection anode tab.
- 2) Connect ammeter (0...50 mA) between PE cable and tab.
- 3) Evaluation of protection anode wear:
Measured value > 1 mA ⇒ protection anode is in working order.
Measured value < 1 mA ⇒ protection anode must be tested or replaced.

10 Faults / troubleshooting

This heat pump is a quality product and is designed for trouble-free operation. Should a fault occur, however, it will be indicated on the heat pump manager display. In this case, consult the "Faults and troubleshooting" page in the operating instructions of the heat pump manager. If you cannot correct the fault yourself, please contact your after-sales service technician.

CAUTION!

Before opening the device, ensure that all circuits are disconnected from the power supply!

After disconnecting the power supply, always wait for at least 5 minutes to allow stored electric charges to dissipate.

CAUTION!

Work on the system must only be performed by authorised and qualified after-sales service technicians.

11 Decommissioning / disposal

Before removing the hydro tower, disconnect it from the power source and close all valves. The heat pump must be installed by trained personnel. Observe all environmental requirements regarding the recovery, recycling and disposal of materials and components in accordance with all applicable standards.

12 Device information

1	Type and order code		HWK 332HC
2	Design		
2.1	Model		Hydro tower with dual differential pressureless manifold and controller
2.2	Degree of protection in accordance with EN 60529		IP 20
2.3	Installation location		Indoors
3	Technical data		
3.1	Heat generation		External
3.2	Buffer tank		
	nominal volume	in litres	100
	permissible operating temperature	°C	85
	max. operating overpressure	bar	3.0
	electrical pipe heater	kW	2, 4 or 6 ¹
	immersion heater (optional)	kW	up to 6
3.3	Hot water cylinder		
	usable capacity	in litres	277
	heat exchanger area	m ²	3.15
	permissible operating temperature	°C	95
	max. operating pressure	bar	10.0
	immersion heater	kW	1.5
3.4	Start-to-leak pressure, safety valve	bar	3.0
3.5	Sound power level	dB(A)	42
3.6	Sound pressure level at a distance of 1 m	dB(A)	35
4	Dimensions, connections and weight		
4.1	Device dimensions ²	H x W x L mm	1920 x 740 x 950
4.2	Tilting dimension	mm	2000
4.3	Device connections		
	for heat generator	inches	1 1/4" external thread / flange
	unmixed heating circuit	inches	1 1/4" external thread / flange
	DHW	inches	1" external thread
	for circulation pipe	inches	3/4" internal thread
	for diaphragm expansion vessel	inches	1" external thread / flange
4.4	Anode diameter	mm	33
4.5	Anode length	mm	690
4.6	Anoden connection thread	inches	1 1/4" internal thread
4.7	Weight of the transport unit(s) incl. packaging	kg	215
5	Electrical connection		
5.1	Control voltage fuse protection		1~/N/PE 230 V (50 Hz) / C13 A
5.2	Supply voltage / fuse protection	($\Sigma P_{\max} = 7.5 \text{ kW}$)	1~/N/PE 230 V (50 Hz) / B35 A 3~/N/PE 400 V (50 Hz) / B20 A
6	Complies with the European safety regulations		3
7	Additional model features		
7.1	Water in device is protected against freezing ⁴		Yes

1. 6 kW on delivery

2. Note that additional space is required for pipe connections, operation and maintenance.

3. See CE declaration of conformity

4. The heat circulating pump and the heat pump manager must always be ready for operation.

13 Dimension Drawings

13.1 Dimension Drawing

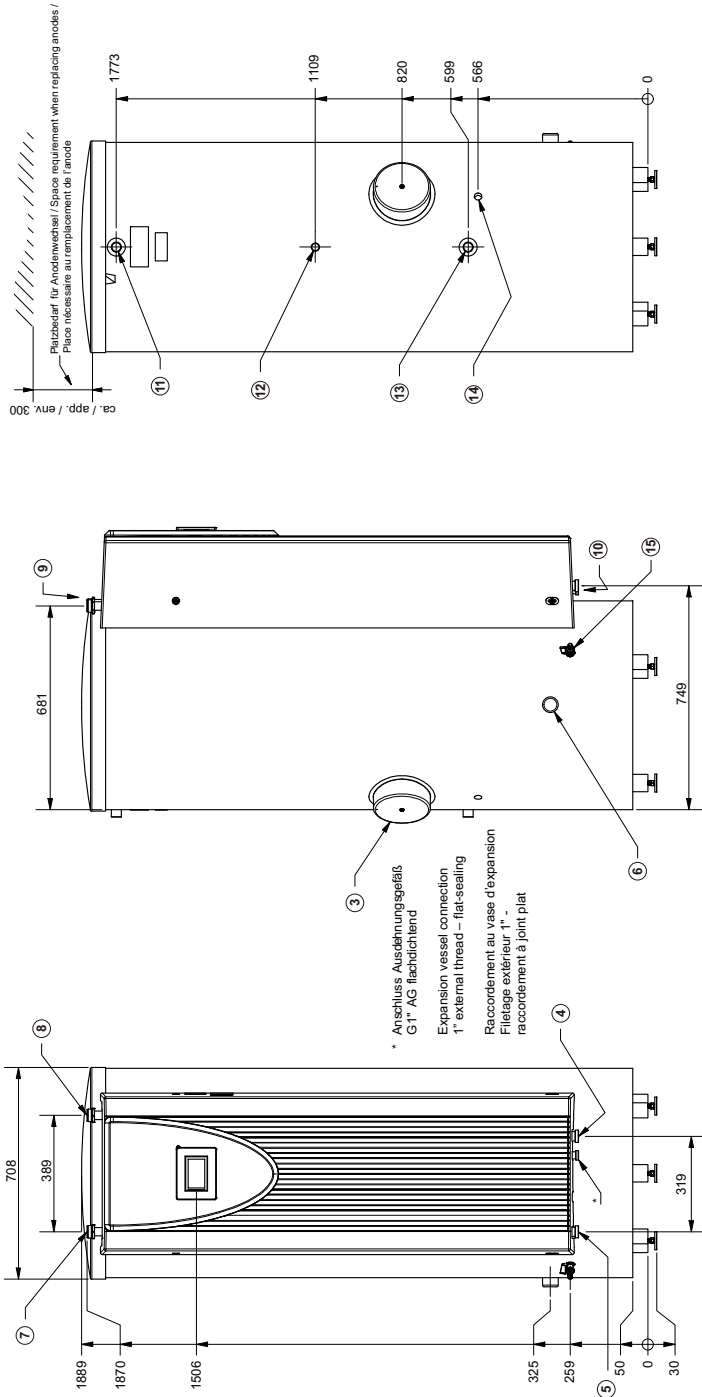

1	2	3	4	5	6	7	8	9	10	11	12	13	14	15
1	2	3	4	5	6	7	8	9	10	11	12	13	14	15
Shutzanode	Kabelkanal unter der Speicherabdeckkappe oben	Elektro-Heizstab 1,5kW	Rücklauf zur Wärmepumpe G 1 1/4" AG flachdichtend	Vorlauf zur Wärmepumpe G 1 1/4" AG flachdichtend	G 1 1/2" (G) für optionalen Anschluss Tauchheizkörper	Heizwasser-Rücklauf G 1 1/4" AG flachdichtend	Heizwasser-Vorlauf G 1 1/4" AG flachdichtend	Kabeleinführung von oben	Kabeleinführung von unten	Warmwasser Austritt R 1" (AG)	Zirkulationsleitung G 3/4" (G)	Kaltwasser-Zulauf R 1" (AG)	Leerrohr Ø 22 (Leitungsdurchführung)	Füll- und Entleerungshahn 1/2" (incl. Schlauchtulie)
Protection anode	Cable duct under the Upper cylinder cover	Electric heating element 1.5 kW	Return to the heat pump 1 1/4" external thread – flat-sealing	Flow from the heat pump 1 1/4" external thread – flat-sealing	1 1/2" (internal thread) For optional immersion heater connection	Heating water return 1 1/4" external thread – flat-sealing	Heating water flow 1 1/4" external thread – flat-sealing	Cable entry from above	Cable entry from below	Hot water outlet R 1" (external thread)	Circulation pipe 3/4" (internal thread)	Cold water inflow R 1" (external thread)	Ductwork Ø 22 (cable gland)	Filling and drain cock 1/2" (incl. hose nozzle)
Anode anticorrosion	Gaine de câble en dessous du couvercle supérieur du ballon	Cartouche électrique chauffante 1,5 kW	Circuit de retour de la pompe à chaleur Filetage extérieur 1 1/4" - raccordement à joint plat	Circuit de départ de la pompe à chaleur Filetage extérieur 1 1/4" - raccordement à joint plat	Filetage intérieur 1 1/2" Pour le raccordement d'une résistance immergée en option	Circuit de retour de l'eau de chauffage Filetage extérieur 1 1/4" - raccordement à joint plat	Circuit de départ de l'eau de chauffage Filetage extérieur 1 1/4" - raccordement à joint plat	Passage de câble par le haut	Passage de câble par le bas	Sortie de l'eau chaude sanitaire Tube filetage extérieur 1"	Conduite de circulation Filetage intérieur 3/4"	Alimentation en eau froide Tube filetage extérieur 1"	Gaine vido Ø 22 (passage de câble)	Robinet de vidange et de remplissage 1/2" (embout compris)

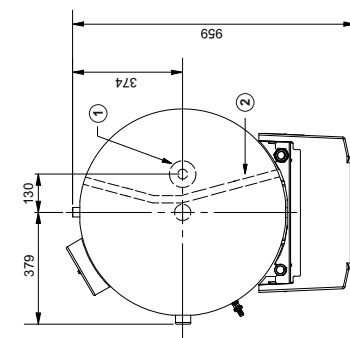

14 Diagrams

14.1 Characteristic curves

Pumpen- / Gerätekenlinie (Heiz- und Wärmepumpenkreis in Betrieb)
 Pump / device characteristic curve (heating circuit and heat pump circuit in operation)
 Courbe caractéristique de la pompe / de l'appareil (circuit de chauffage et de PAC en service)

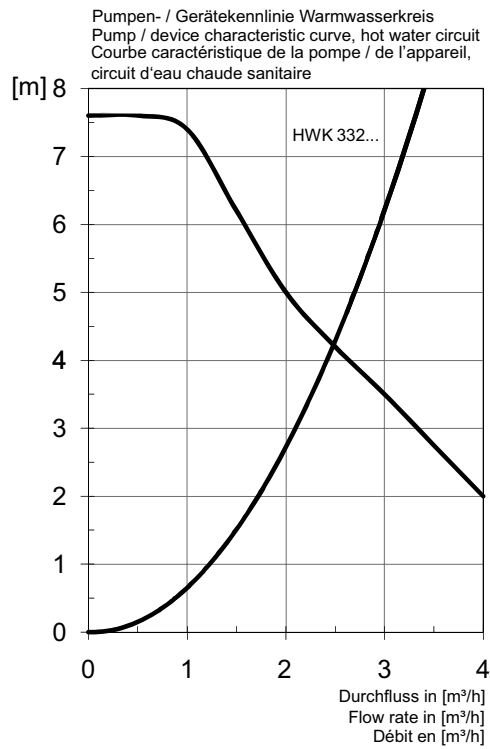
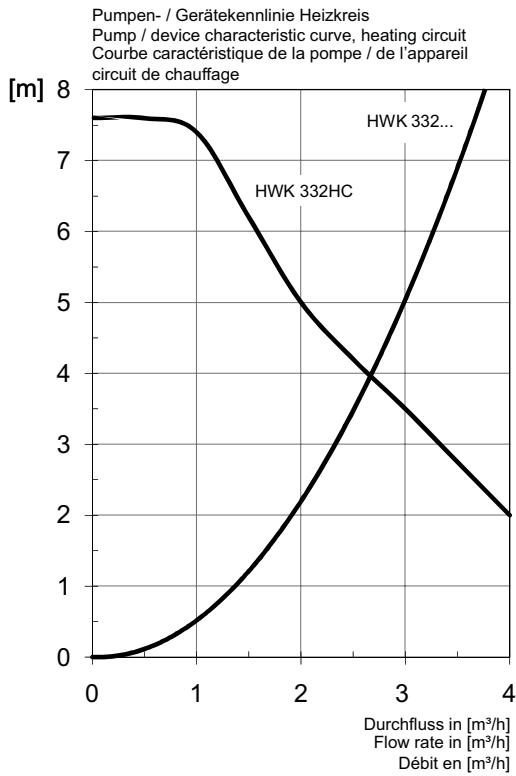
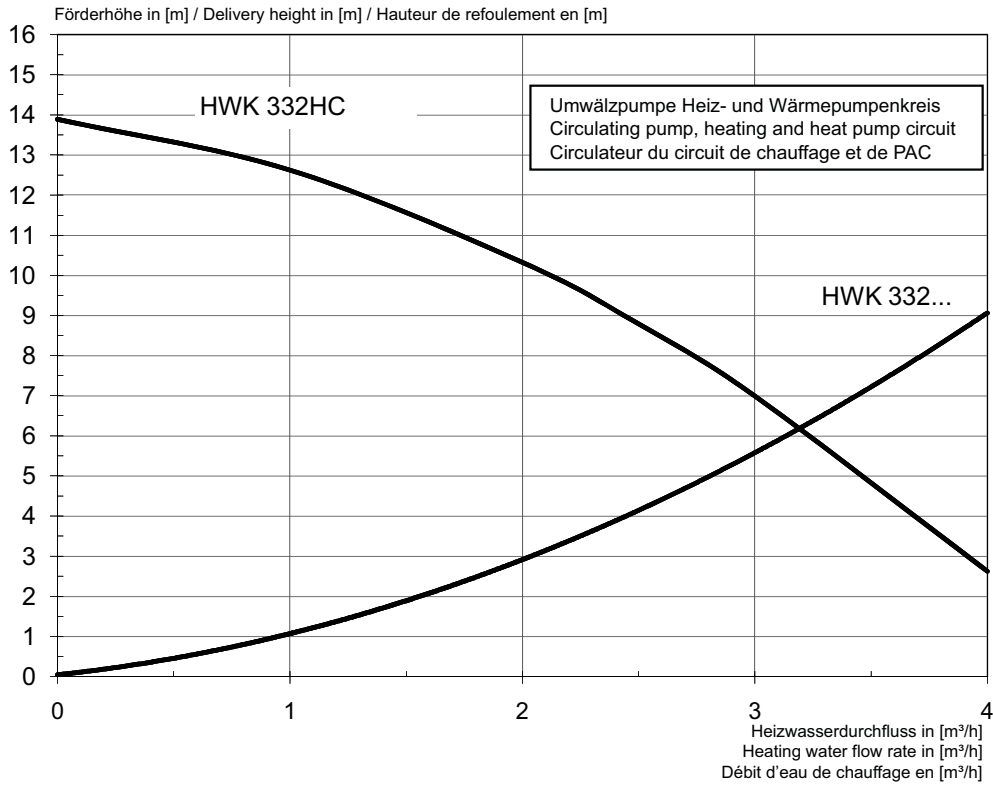

15 Integration diagram

15.1 Mono energy heat pump heating system with one heating circuit, buffer tank and hot water cylinder

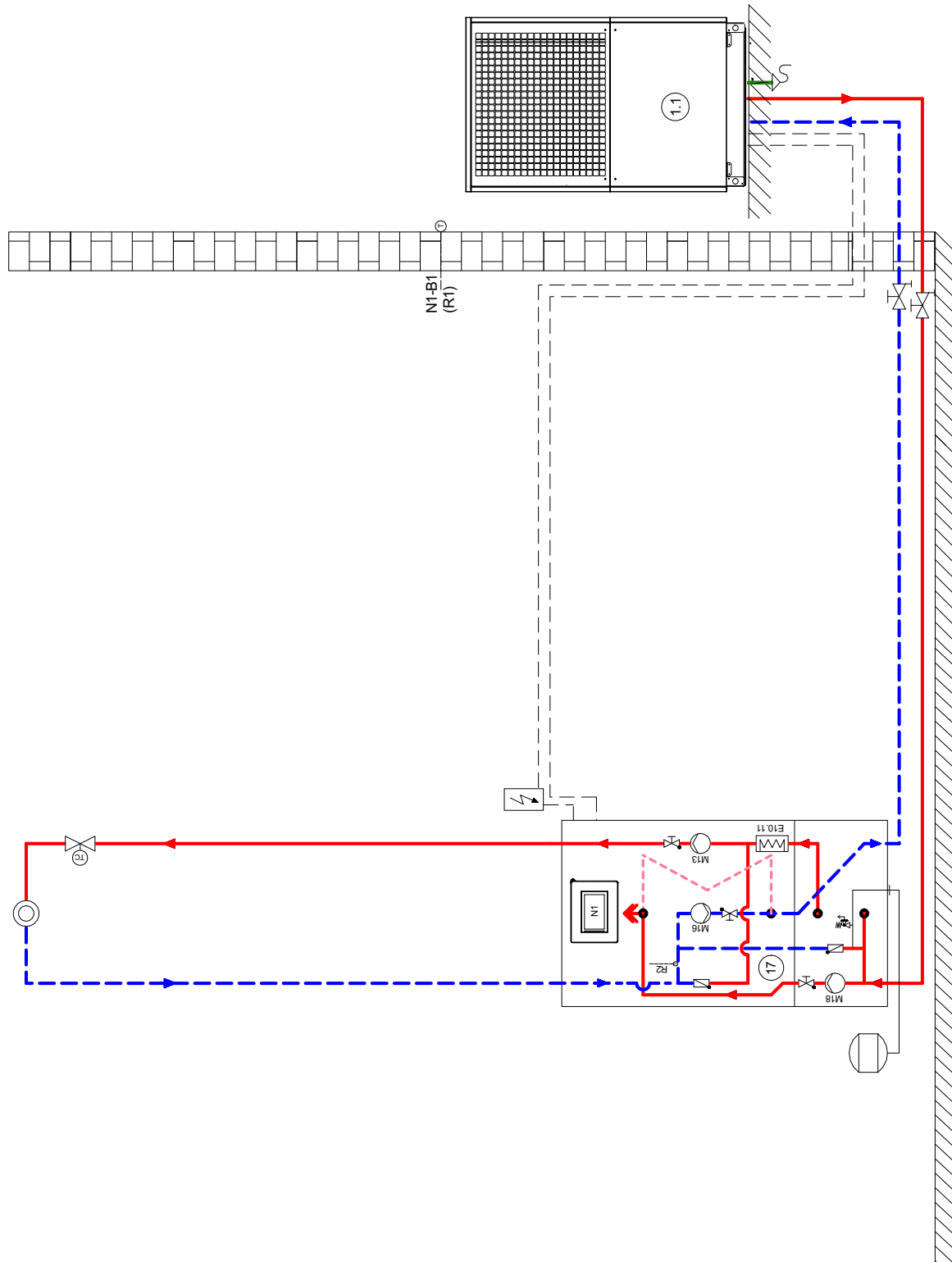

i NOTE

The hydraulic integration diagram is an example and intended only as an aid. The system requires professional and safety approved layout by a specialist planner. All information in the section on installation and the corresponding safety notes must be observed at all times.



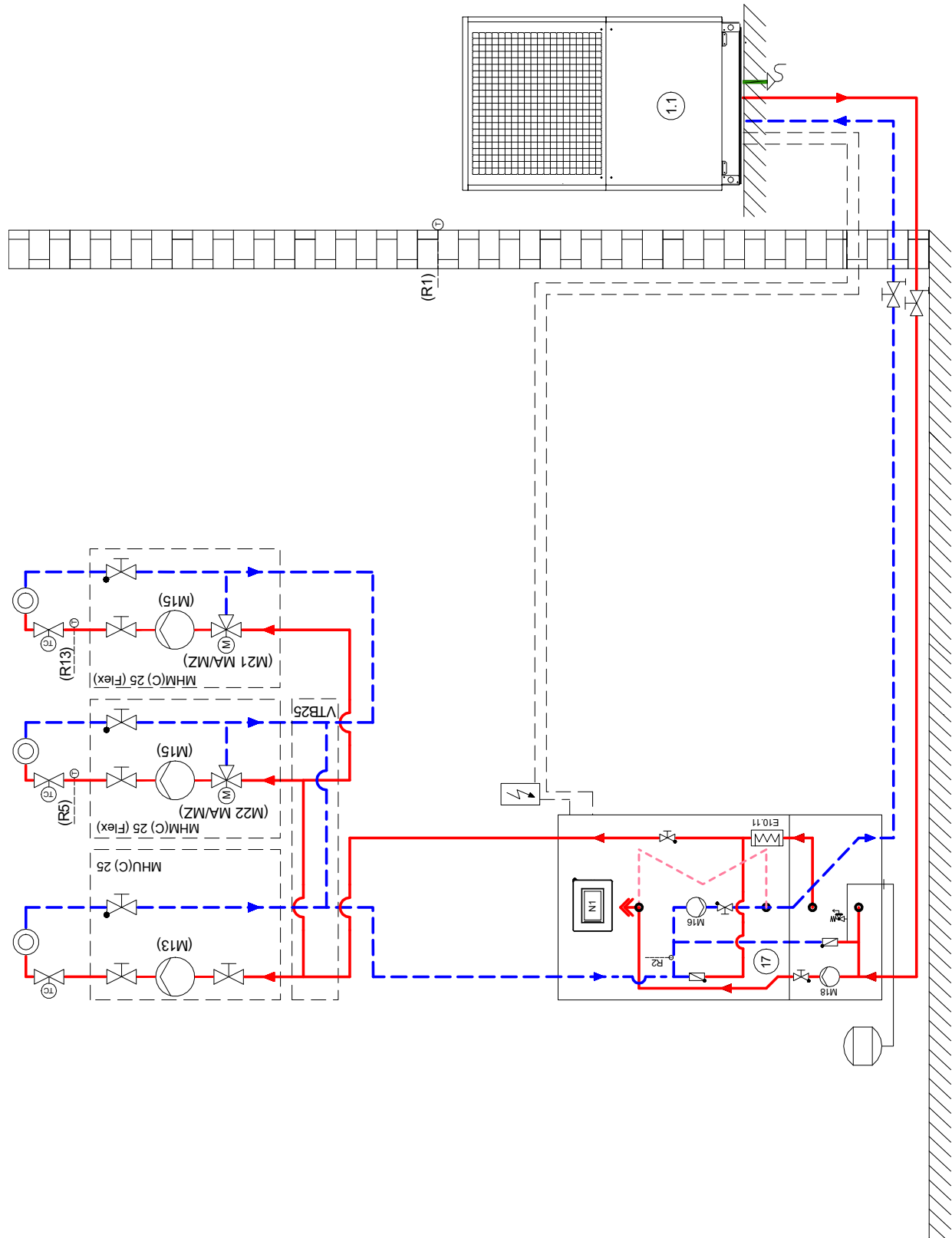













15.2 Mono energy heat pump heating system with three heating circuits, buffer tank and hot water cylinder



i NOTE

The hydraulic integration diagram is an example and intended only as an aid. The system requires professional and safety approved layout by a specialist planner. All information in the section on installation and the corresponding safety notes must be observed at all times.

15.3 Legend

	Shutoff valve
	Three-way mixer
	Circulating pump
	Expansion vessel
	Room temperature-controlled valve
	Shutoff valve with check valve
	Shutoff valve with drainage
	Safety valve combination
	Heat consumer
	Temperature sensor
	Flexible connection hose
	Check valve
	Heat pump
	Hydro tower
	Immersion heater
	Heat circulating pump for heating circuit
E10.1	Heat circulating pump for heating circuit 2
M13	Auxiliary circulation pump
M15	Hot water loading pump
M16	Mixer for main circuit or heating circuit 3
M21	Mixer for heating circuit 2
M22	Heat pump manager
N1	External wall sensor
R1	Return flow sensor (integral)
R2	Temperature sensor for heating circuit 2
R5	Sensor for heating circuit 3 / renewable sensor
R13	Shutoff valve



Glen Dimplex Deutschland

Head office

Glen Dimplex Deutschland GmbH
Am Goldenen Feld 18
D-95326 Kulmbach

T +49 9221 709-101
F +49 9221 709-339
info@dimplex.de
www.dimplex.de

On site service

After-sales service, technical support and spare parts. Assistance before and after installation of your equipment

T +49 9221 709-545
F +49 9221 709-924545
Mon - Thu: 7:00 to 17:00
Fri: 7:00 to 15:00
service@dimplex.de

Request after-sales service on the internet:
www.dimplex.de/dimplex-service