

Luft-Wasser-Wärmepumpe

LA 0712C

1

electrical layout



+A300
Elektronverteilung
electrical distribution system
distribution électrique

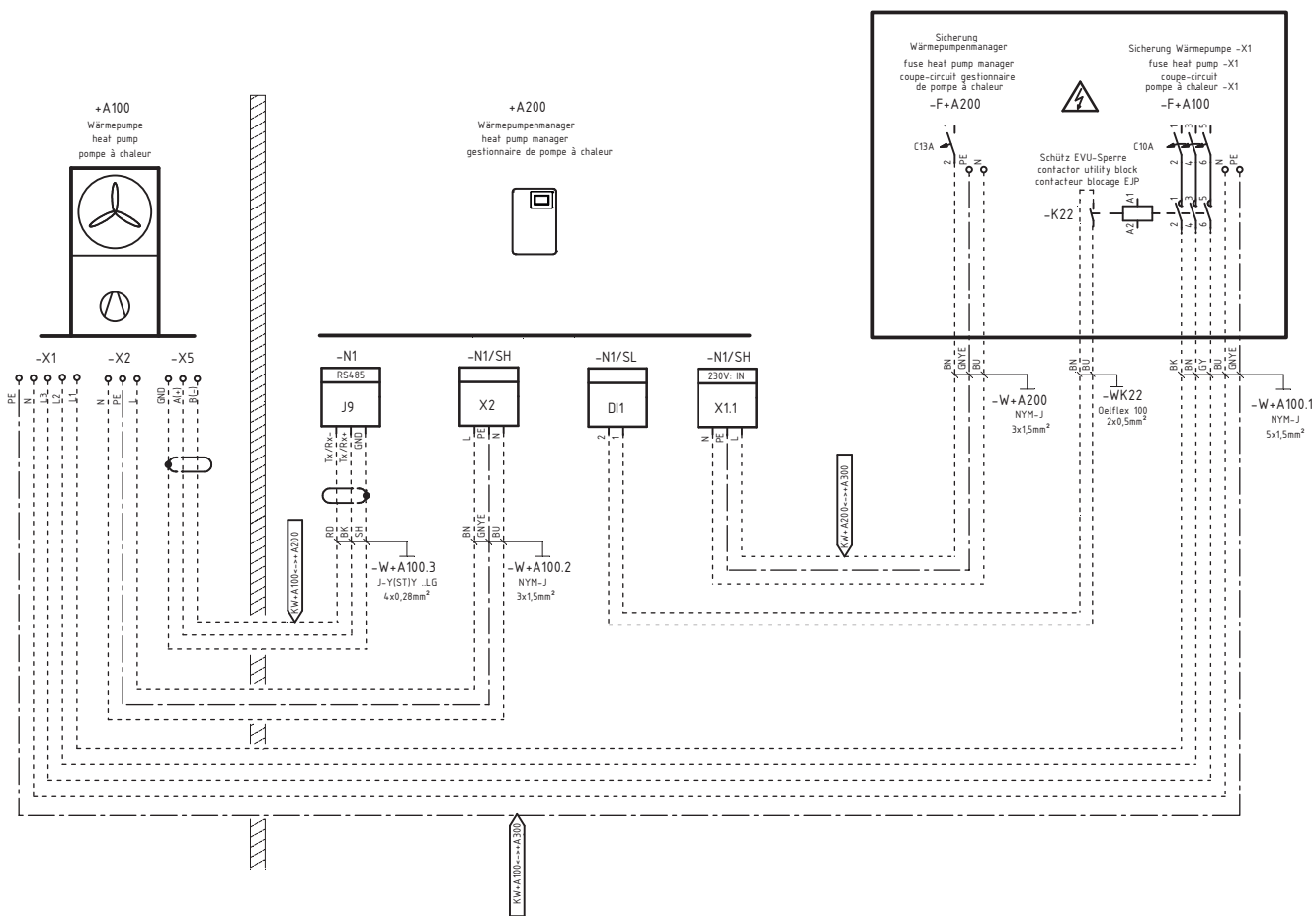



2

hydraulic

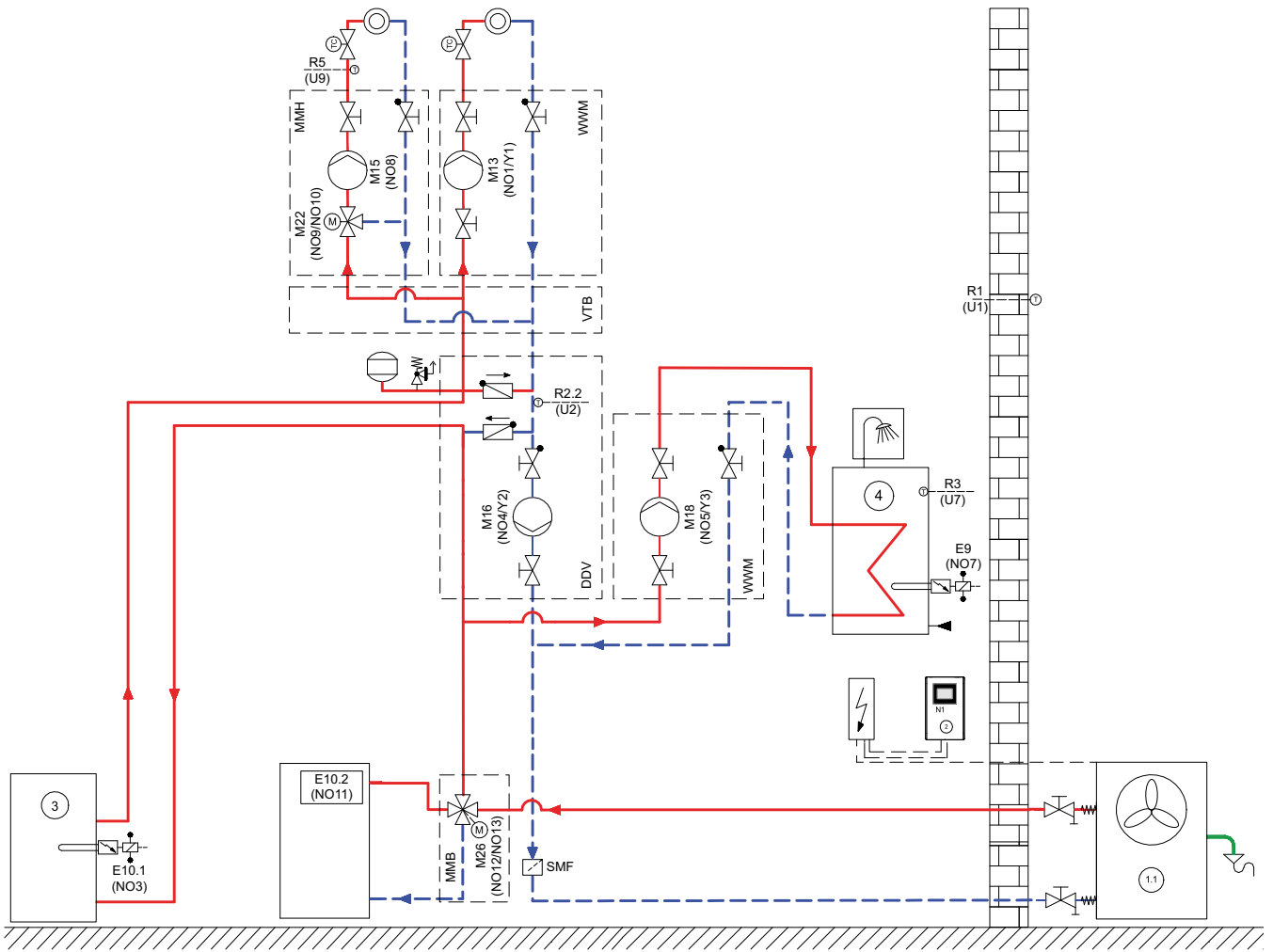

hydraulic 1

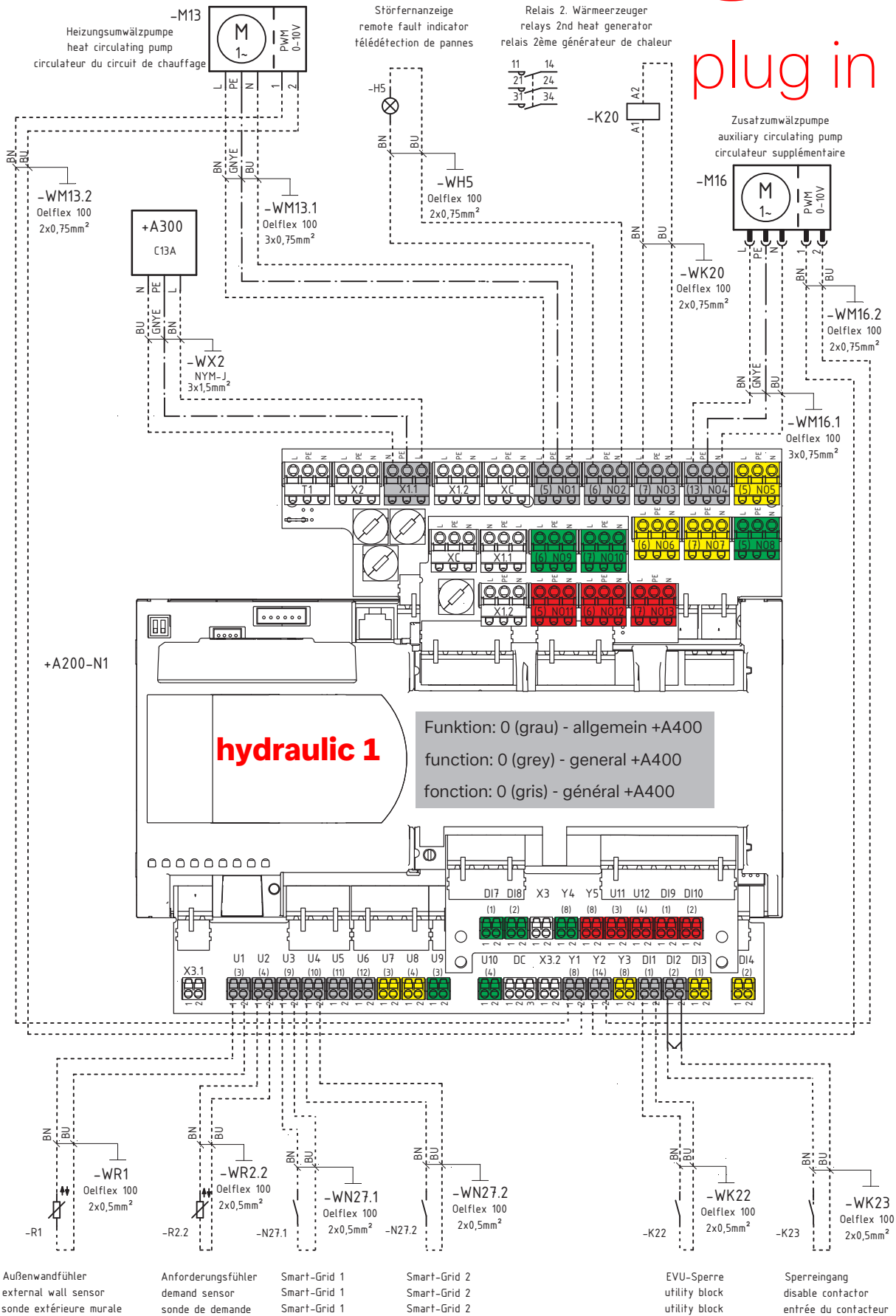

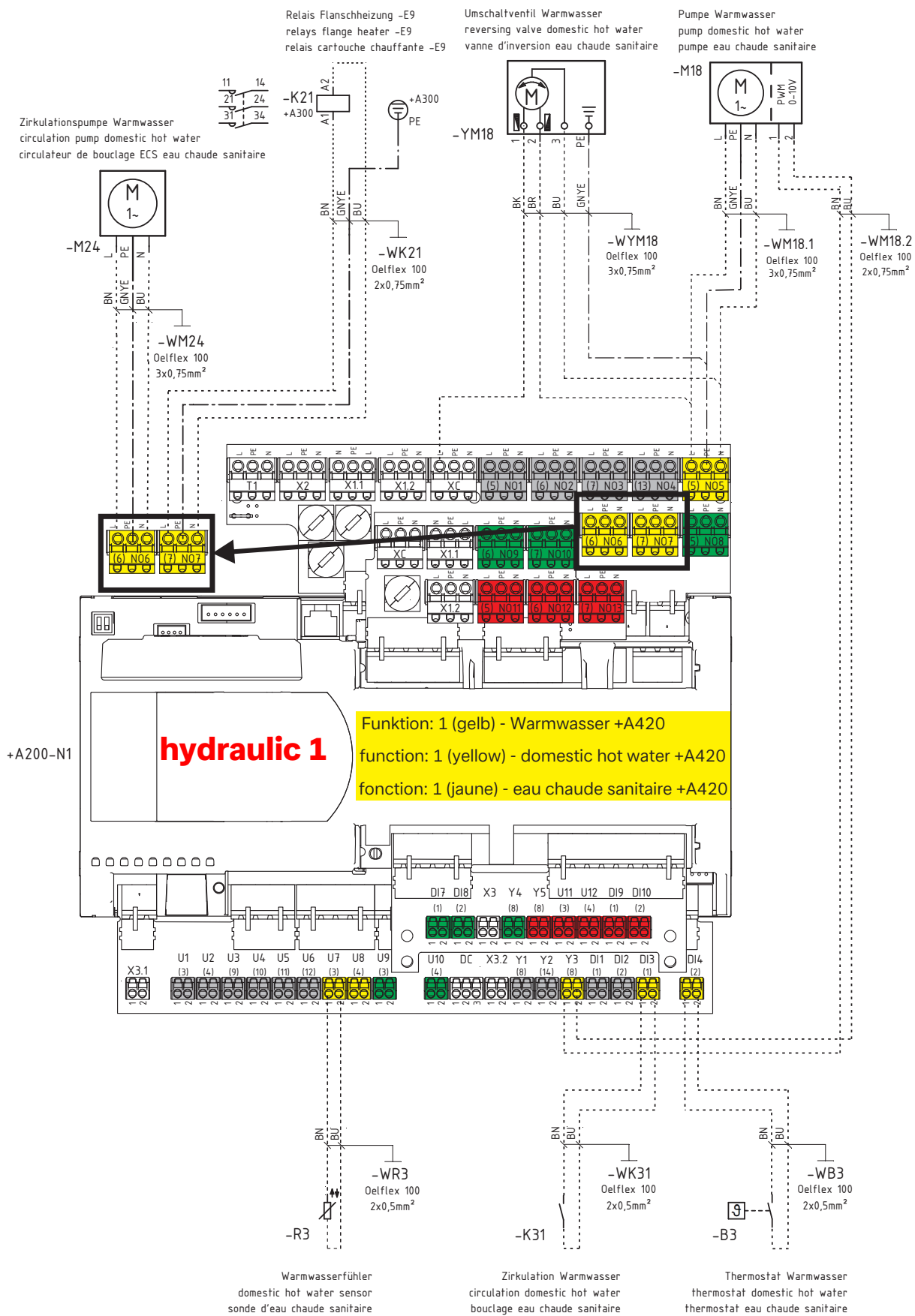

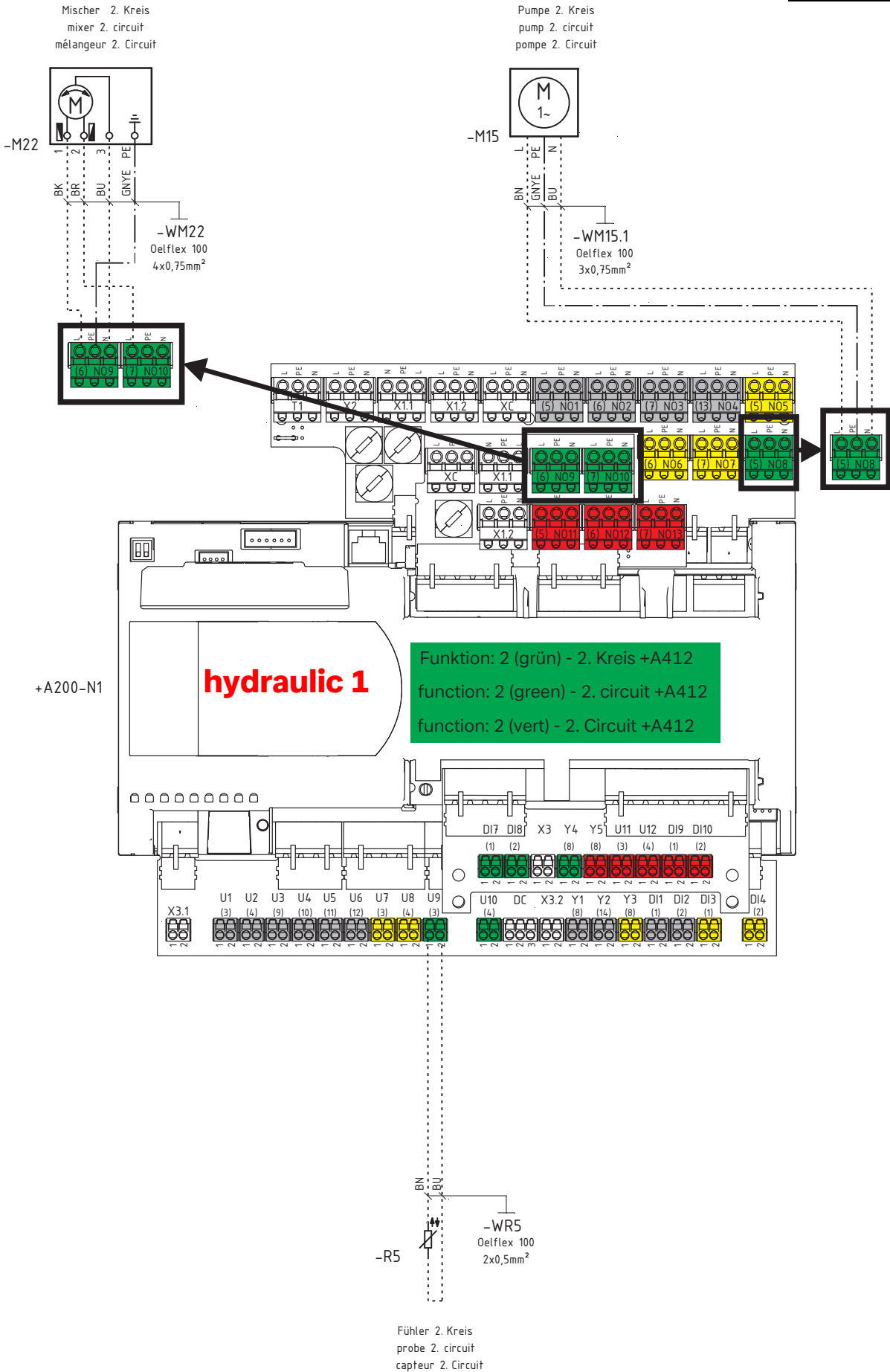



Wärmeerzeuger bivalent
heat generator bivalent
générateur de chaleur bivalente

Mischer bivalent
mixer bivalent
mélangeur bivalent

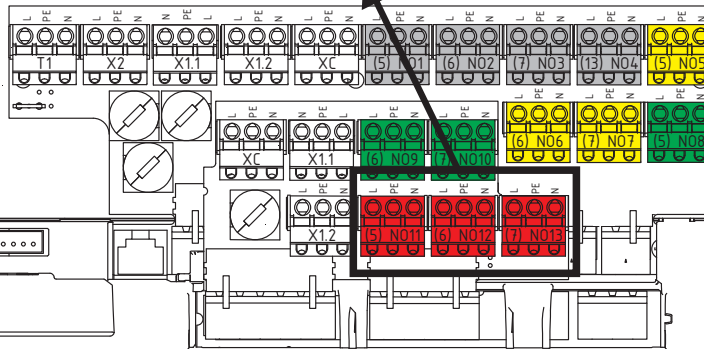
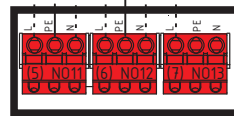
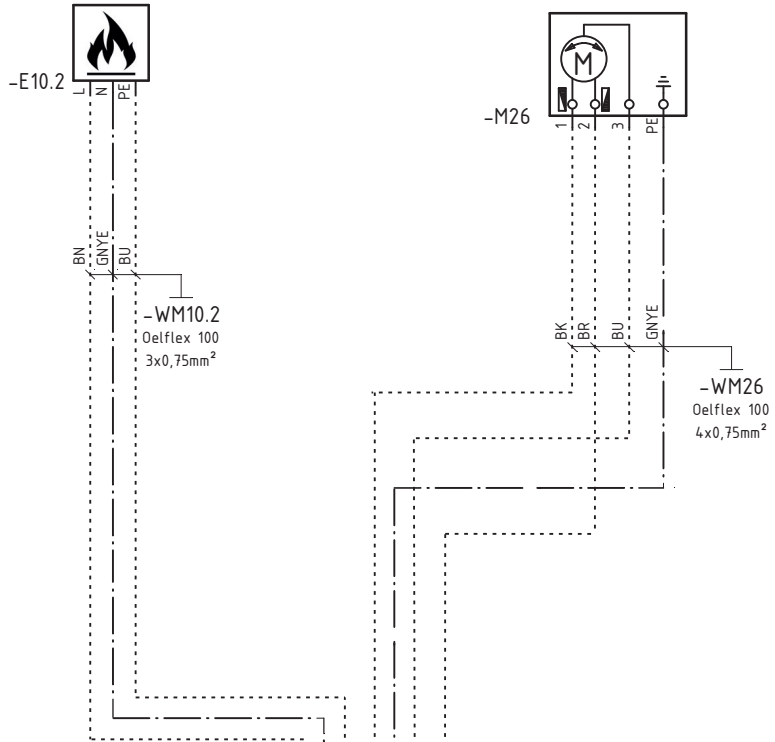

+A200-N1

hydraulic 1

Funktion: 3 (rot) -bivalent +A441
function: 3 (red) -bivalent +A441
fonction: 3 (rouge) - bivalent +A441

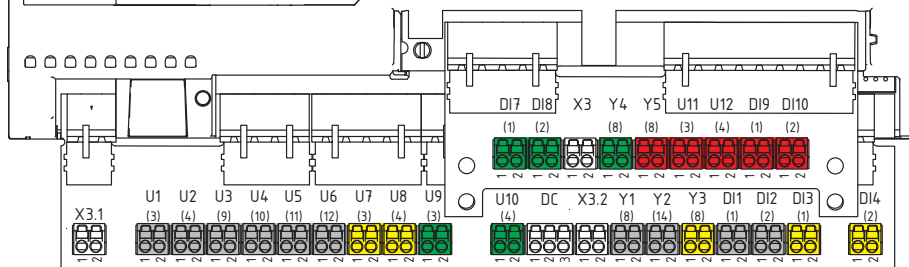

4



hydraulic

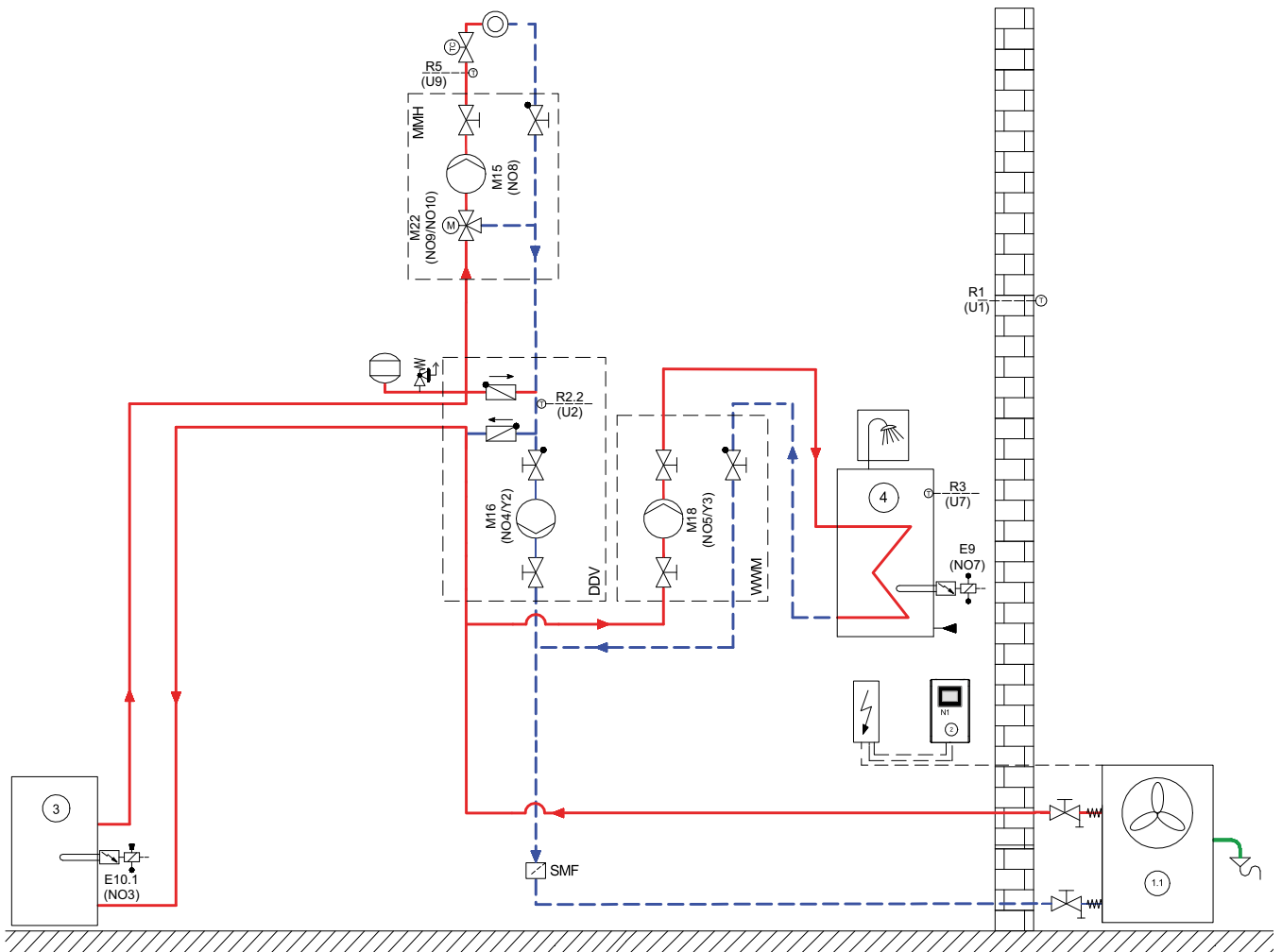

hydraulic 2



Glen Dimplex
Deutschland

Dimplex

5

plug in

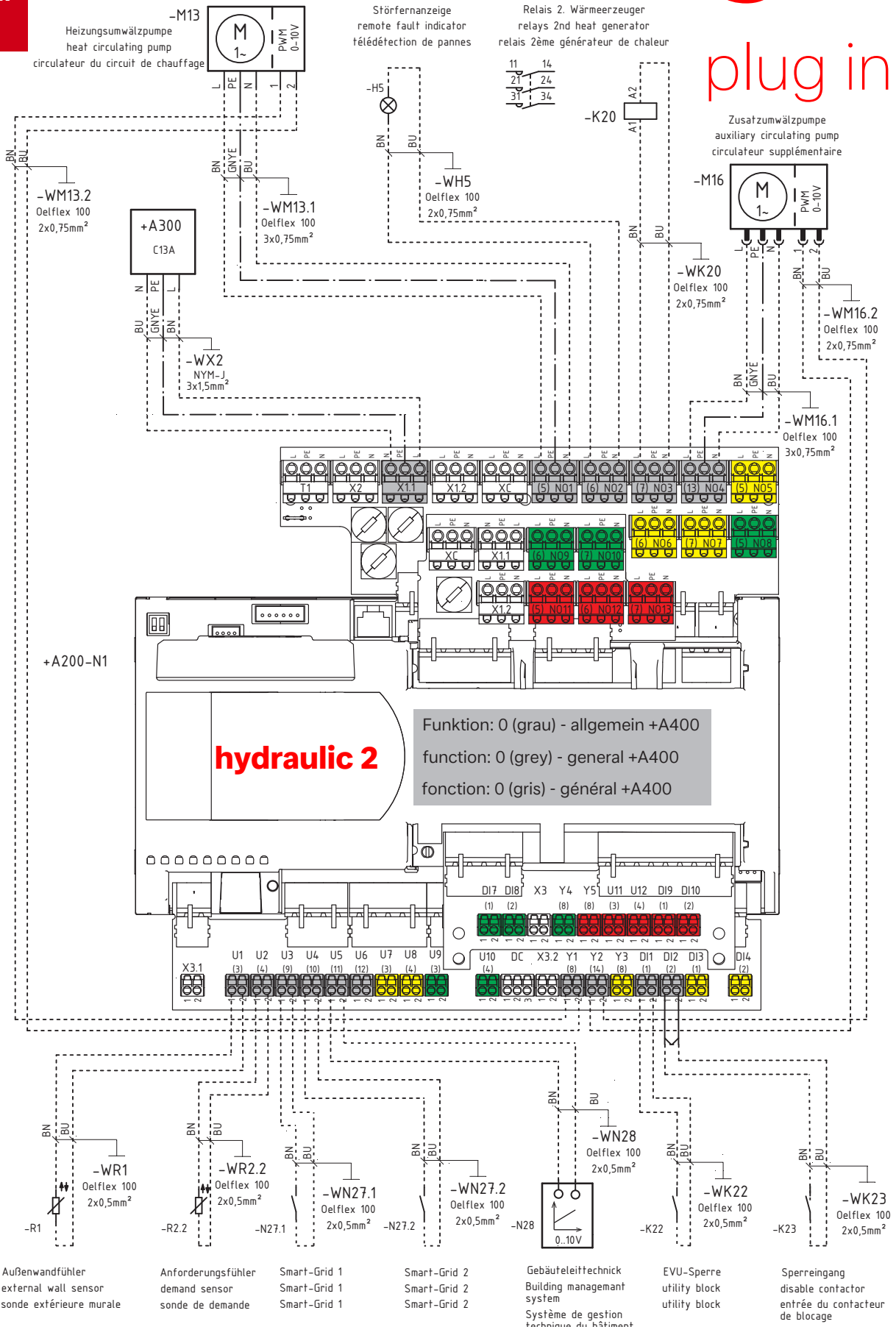

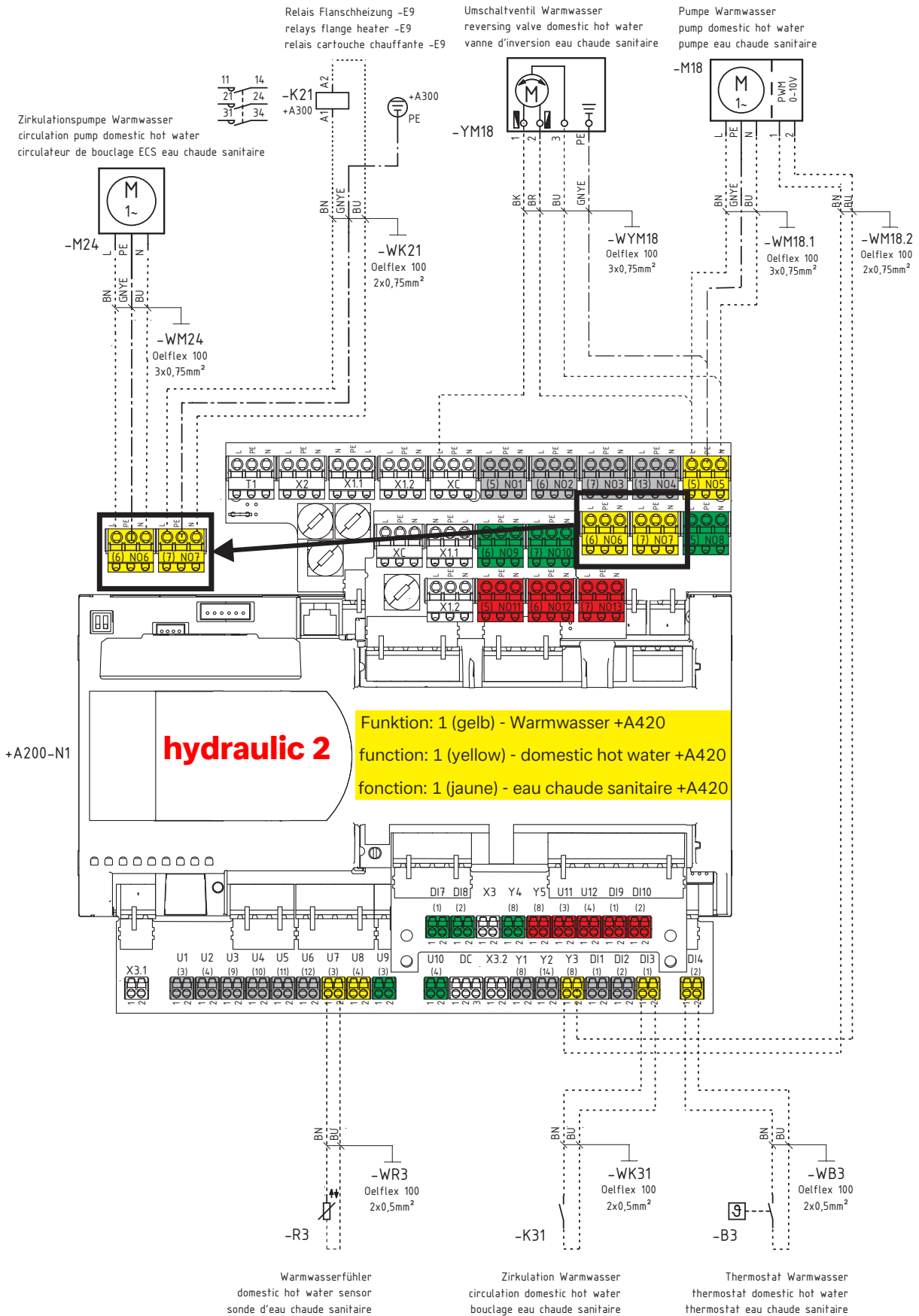

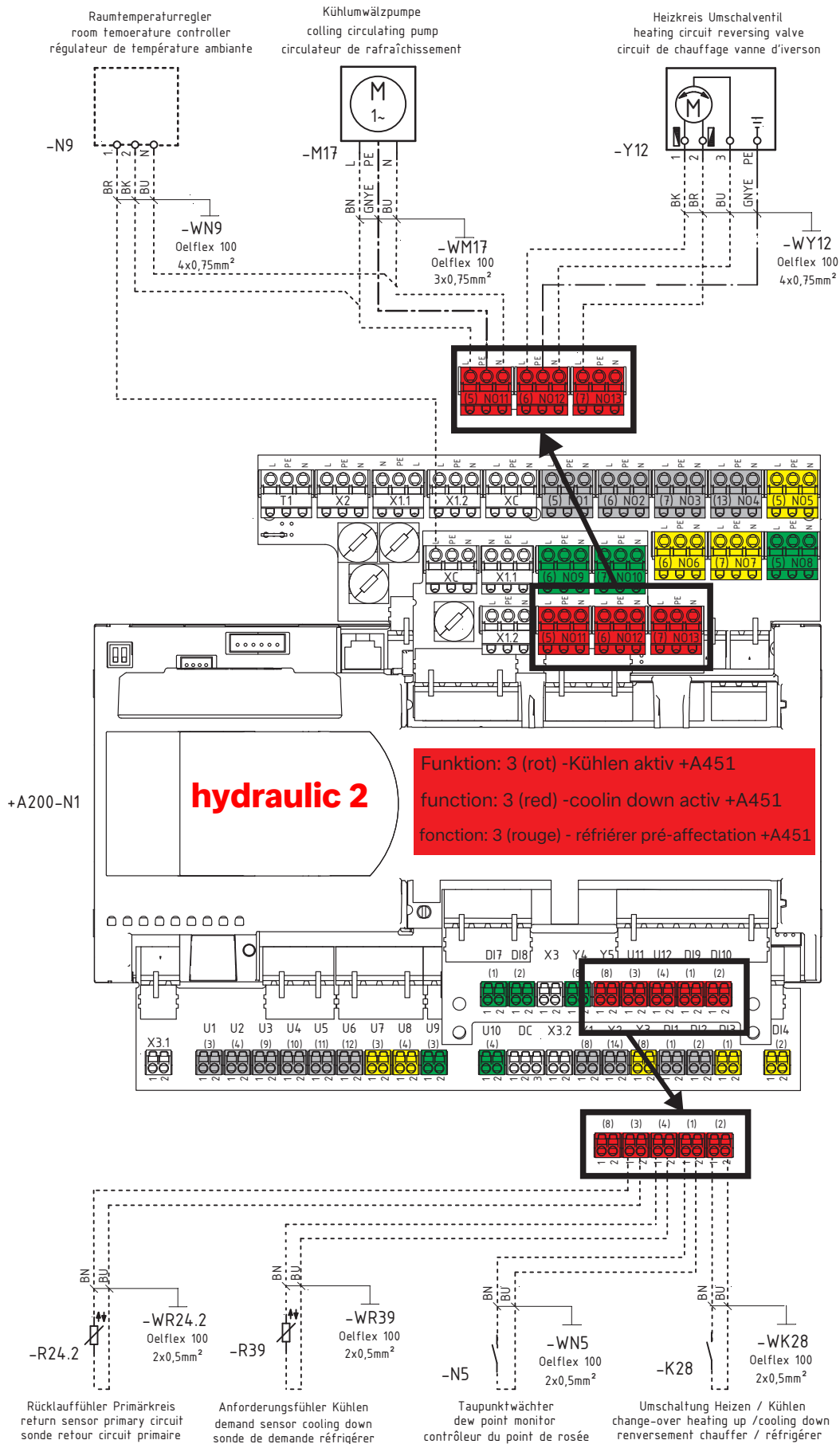



**Glen
Dimplex**
Deutschland

Dimplex