

# Luft-Wasser-Wärmepumpe

## LA 35TBS

# 1

## electrical layout



+A300  
Elektroverteilung  
electrical distribution system  
distribution électrique

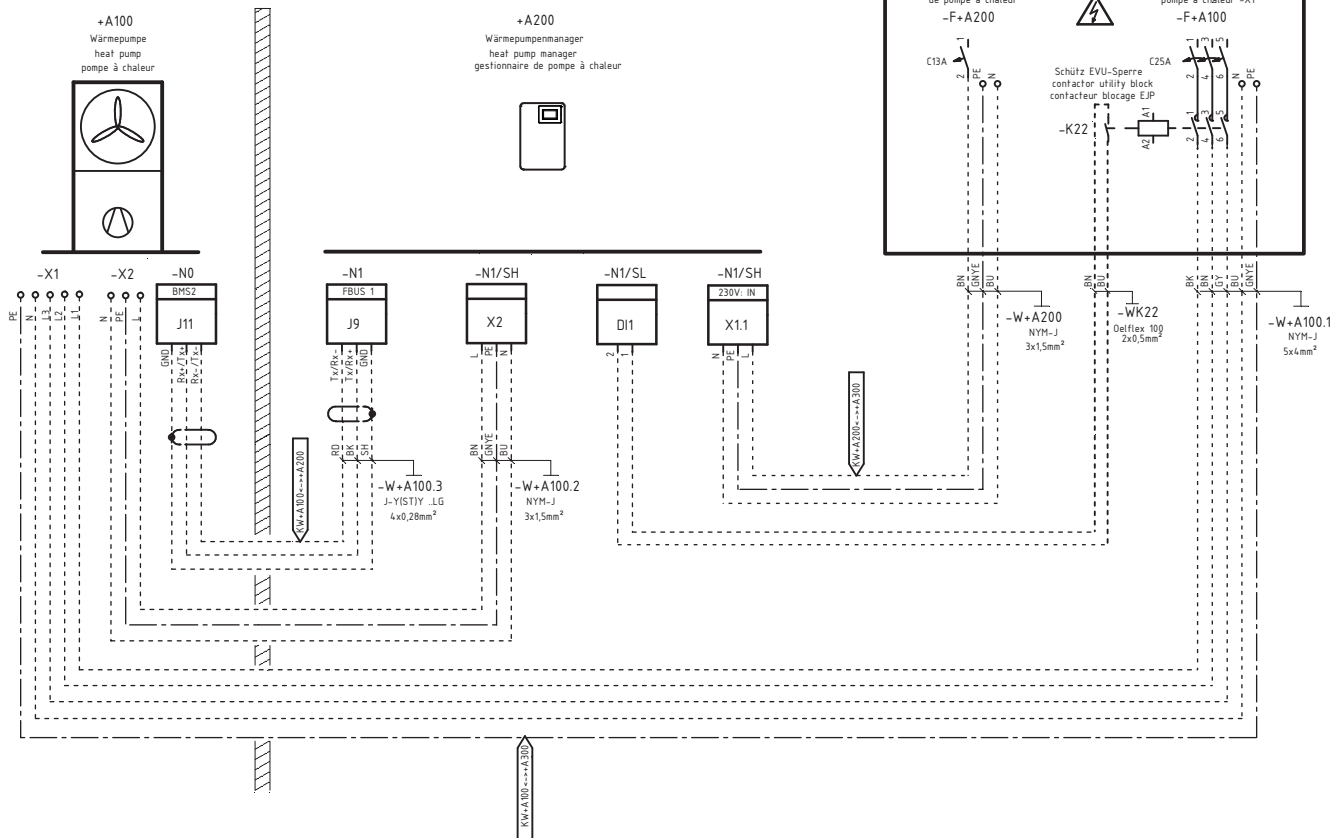



# 2

## hydraulic

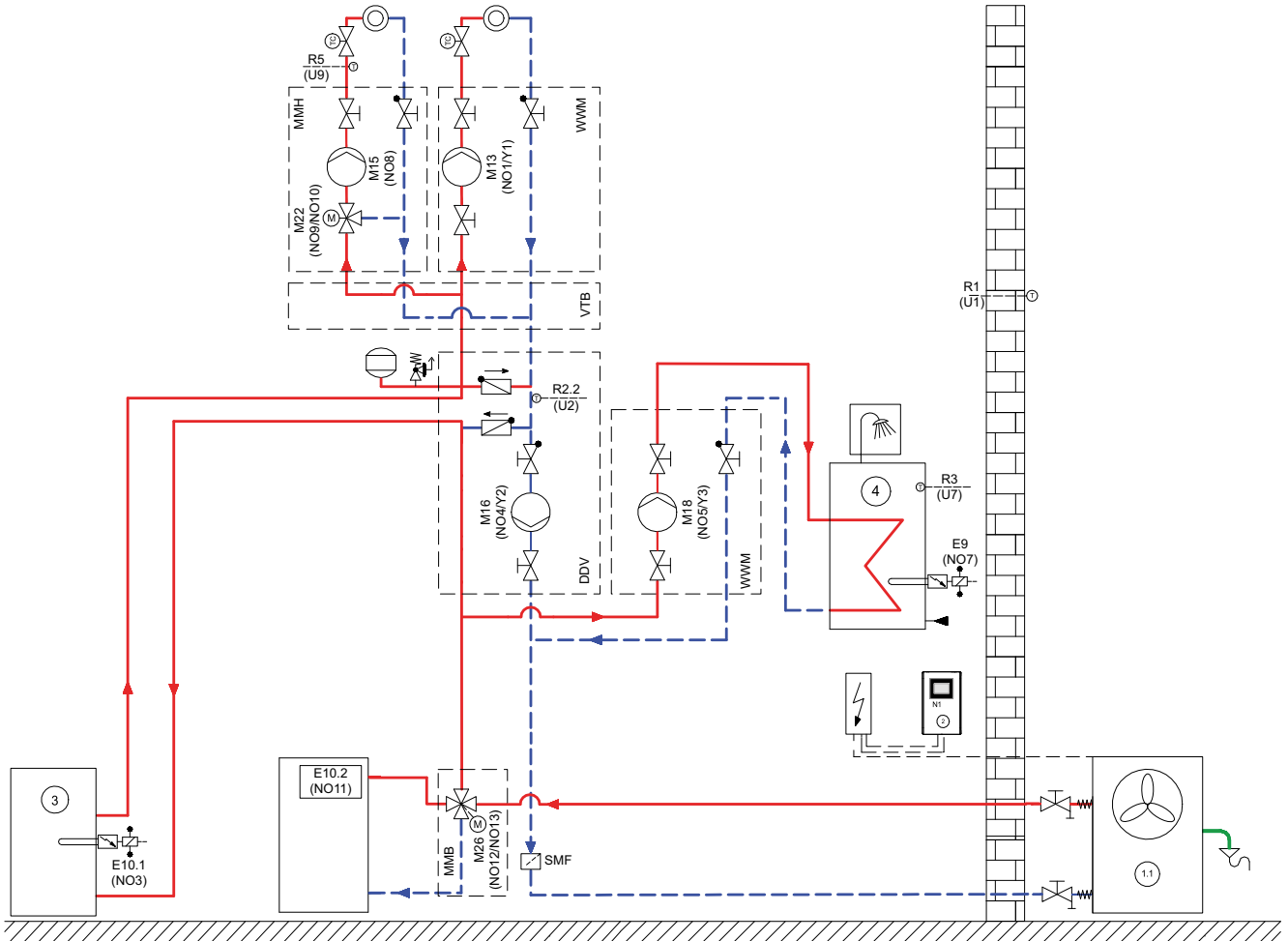

## plug in

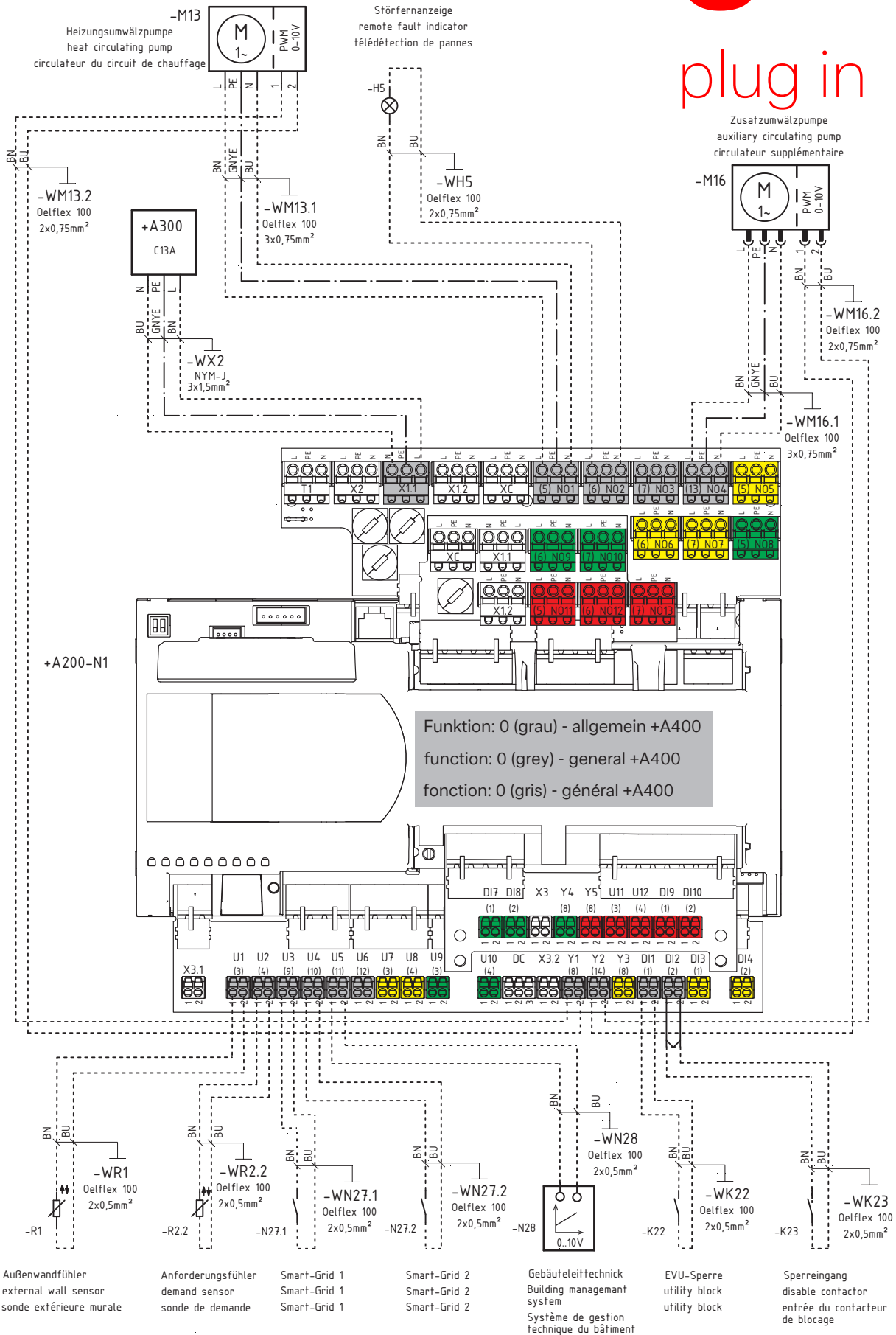



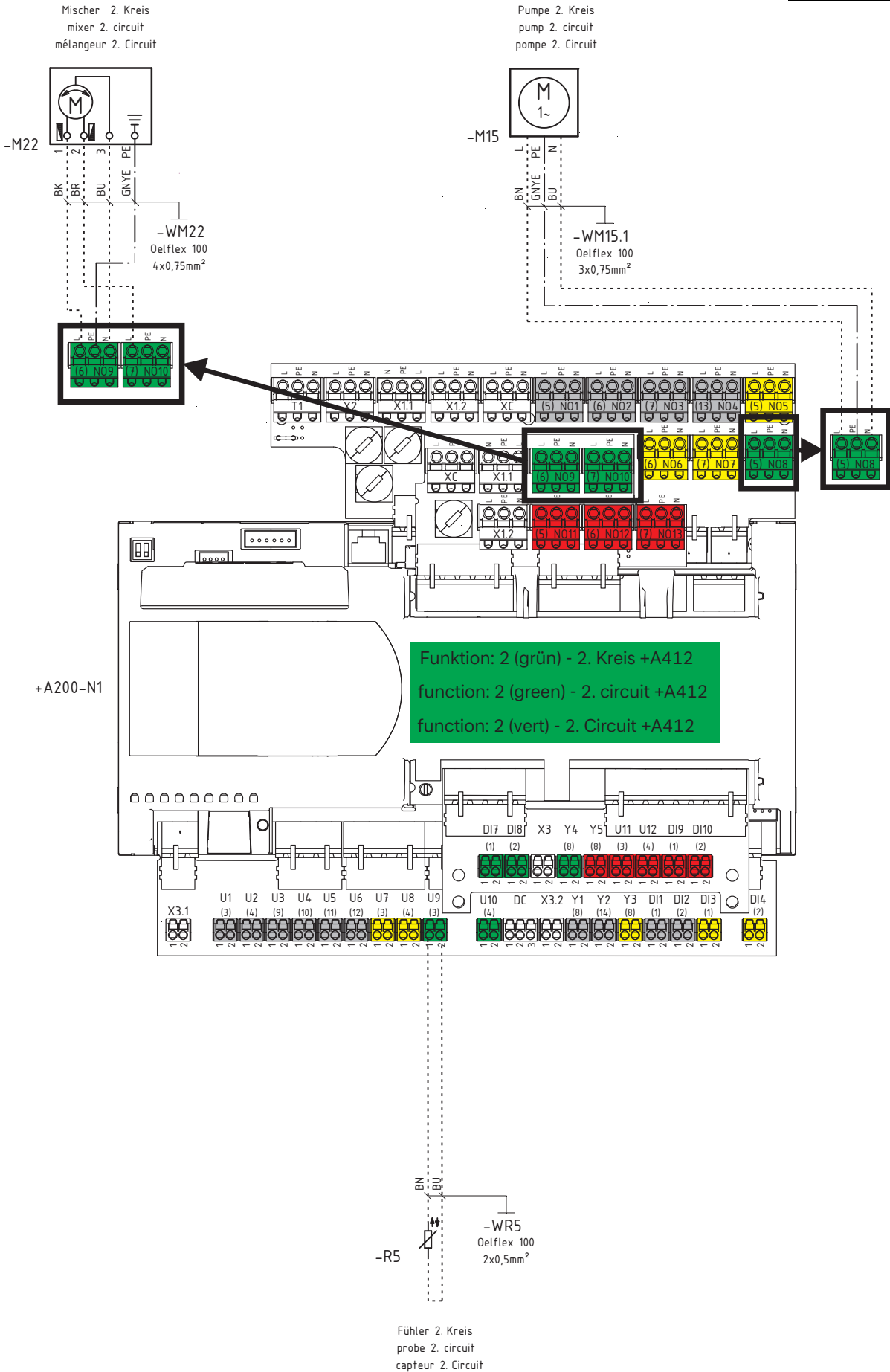



Wärmeerzeuger bivalent  
heat generator bivalent  
générateur de chaleur bivalente

Mischer bivalent  
mixer bivalent  
mélangeur bivalent

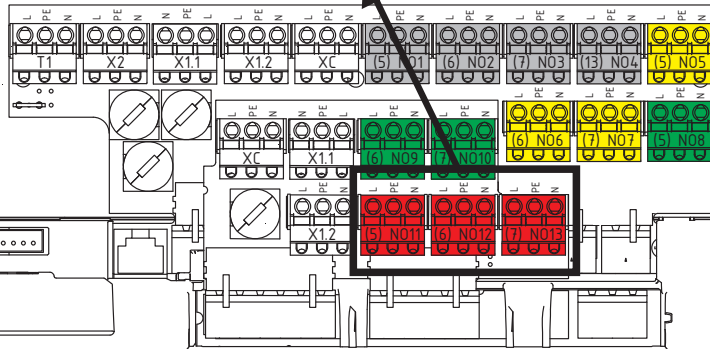
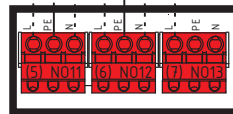
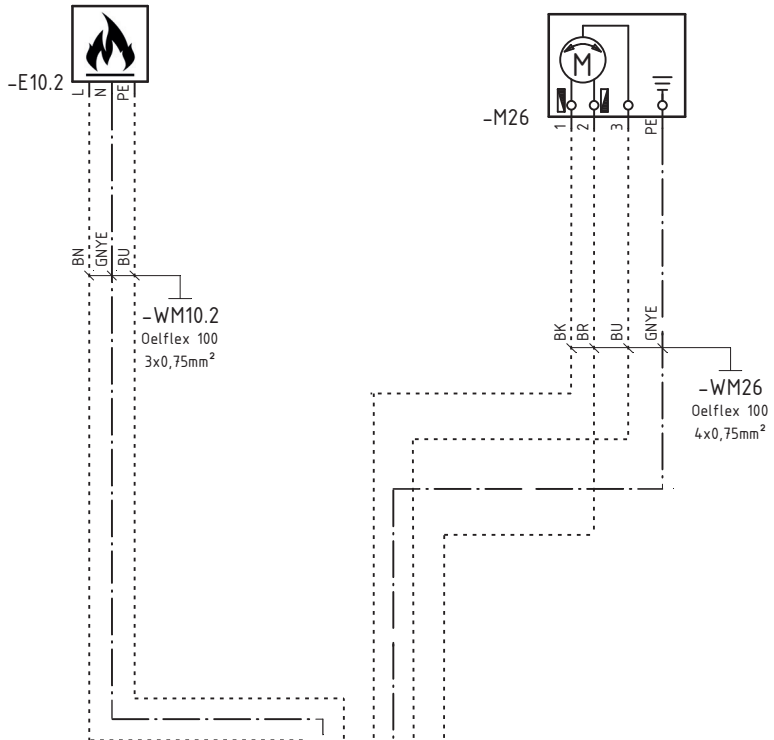

+A200-N1

Funktion: 3 (rot) -bivalent +A441  
function: 3 (red) -bivalent +A441  
fonction: 3 (rouge) - bivalent +A441

